

# GreenSource i Series Model SV Water Source Heat Pump 1/2 to 6 Ton

Engineering  
Submittal  
Sheet



# BOSCH

## Overview and Certifications



Made in  
the U.S.A.



## Standard Features, Factory Installed Options, and Field Install Accessories

### Standard Features

- ▶ **Available in Horizontal and Vertical Cabinets**
  - Constructed using galvanized steel
  - Standard hanging bracket kits on HZ units for suspending the unit from field supplied hanger rods
- ▶ **Single Stage Compact**
  - Up to 16.9 EER (GLHP)
  - PSC blower motors for all sizes except (041, 060, 070)
  - ECM constant torque blower motors standard for sizes 041, 060, 070
- ▶ **Unit Configuration**
  - Left hand or right hand return air
  - Top or end supply air
  - Copper or Cupro-Nickel Coaxial Coil
- ▶ **Standard 1" Throwaway Filter with 2 side Filter Rack**
- ▶ **1/2" Dual Density Fiber Insulation**
  - Non-combustible, non-hydroscopic and does not support fungal growth
  - Meets NFPA 90A and 90B for fire protection
  - Meets the GREENGUARD Indoor Air Quality Standard
  - All panels are insulated using 1.5 lb./cu.ft. density micromat fiberglass insulation for both thermal insulation and noise reduction
- ▶ **Compressors**
  - Floating compressor base pan for quiet operation
  - Rotary type compressors on sizes 007 through 018
  - Scroll type compressors on sizes 024 through 070
- ▶ **TXV (Thermal Expansion Valve)**
  - Improves refrigerant management and efficiencies

# GreenSource i Series Model SV

## Water Source Heat Pump ½ to 6 Ton



### Standard Features, Factory Installed Options, and Field Install Accessories continued..

#### ► Reliability - Durability - Serviceability

- Tin plated coil
- UPM circuit board with communicating features
- Completely serviceable from front of unit as well as insulated bulkheads allow the unit to be serviced during operation

#### ► DuoGuard™ Evaporator Coil

- Tin Electro-Plated Copper Tubing Hair Pins with high-tech polymer coated Aluminum fins will protect the evaporator coil from most forms of corrosive elements in the airstream

#### ► Electronic Circuit Board UPM

- The electronic circuit board provides protection with:
  - Random Start of Unit
  - Anti-Short Cycling (5 minute delay)
  - Alarm communicating output
  - Low pressure switch bypass at cold water start up
- It also monitors and communicates standard safety features/alerts/operation/protection:
  - Low Pressure Switch
  - High Pressure Switch
  - Evaporator Freeze Protection
  - Water Coil Freeze Switch
  - Condensate Overflow Switch
- This circuit board can communicate with a Bosch thermostat that alerts the customer of adverse conditions

#### ► 75 VA Transformer

#### ► Warranty

- 1 year all parts limited warranty
- 5 year compressor limited warranty
- For full warranty details:  
<https://www.bosch-climate.us/support-center/product-warranty-library/residential-heat-pumps-geothermal-warranty-documents.html>

#### ► Field Configurable Horizontal Discharge Air Conversion

- The horizontal conversion allows end blow to straight through conversion of discharge air, as factory installed straight through configuration for HZ units is no longer available.

#### ► Water Connections

- All water connections are heavy duty bronze FPT fittings securely fastened to the unit corner post

### Factory Installed Options

#### ► Cupro-nickel Coil

- Recommended in conditions anticipating moderate scale formation or in brackish water

### Field Install Options

#### ► Thermostats

- Bosch thermostats are fully customized to meet your individual needs. Bosch offers communicating thermostats that can display alert messages without having to go to the unit.

#### ► Externally Mounted Duct Heater Kits

#### ► Swivel Water Connections

- ¾" or 1" FPT Swivel Water Connection

#### ► Pump/Valve Relay Kit

- This relay is used to energize a supply pump or solenoid valve when there is a call for compressor operation. This relay can be used to switch either high or low voltage power.

#### ► SmartStart Assist Kit

- An option which provides a means of reducing inrush currents at compressor startup. Light flickering is eliminated, and a smooth start is achieved (only available on scroll compressor models).

#### ► Stainless Steel Hose Kits

- Available in various lengths and diameters depending on the need for your application.

#### ► Flow Center Kits

# Greensource i Series Model SV

## Water Source Heat Pump ½ to 6 Ton



### Model Nomenclature

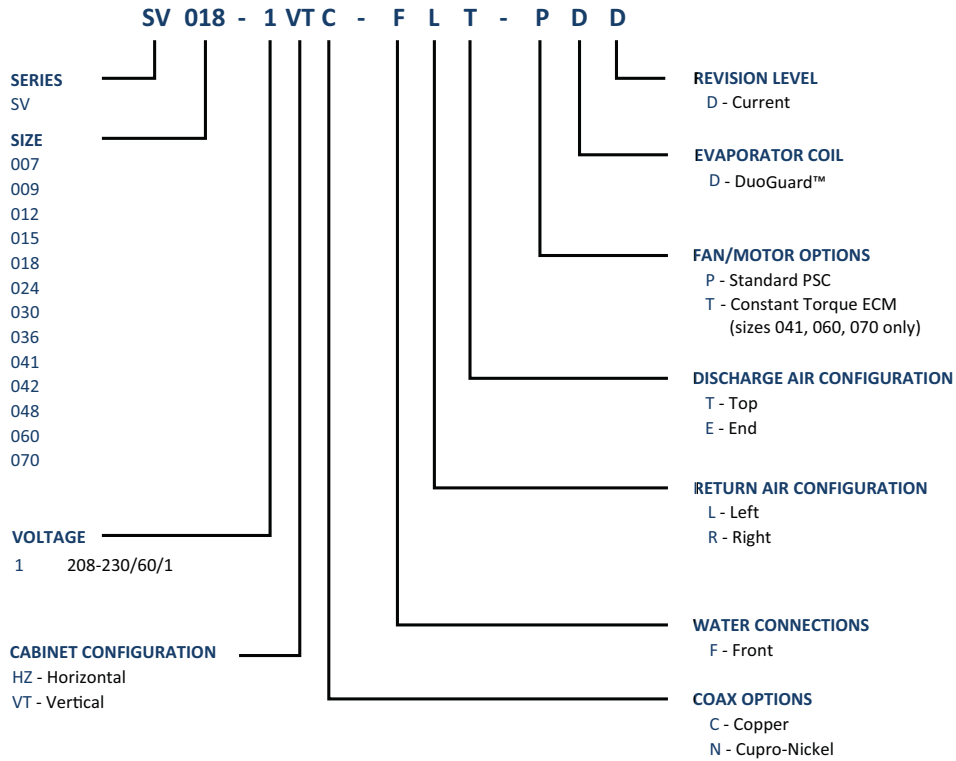

### AHRI/ANSI 13256-1 Capacity and Efficiency Data

Models	Motor Option	Water Loop Heat Pump				Ground Loop Heat Pump			
		Cooling 86 °F		Heating 68 °F		Cooling 77 °F		Heating 32 °F	
		Capacity (Btuh)	EER (Btuh/W)	Capacity (Btuh)	COP	Capacity (Btuh)	EER (Btuh/W)	Capacity (Btuh)	COP
007	PSC	6,100	13.20	7,800	5.10	6,800	15.10	4,900	3.40
009	PSC	8,200	12.40	9,900	4.70	8,700	14.60	5,700	3.20
012	PSC	10,900	12.20	13,000	4.30	11,800	14.10	8,700	3.20
015	PSC	14,200	12.80	16,100	4.40	14,200	14.60	11,300	3.30
018	PSC	18,200	14.10	20,200	4.60	19,200	16.15	14,300	3.50
024	PSC	24,300	14.20	27,400	5.00	25,400	16.90	18,100	3.55
030	PSC	28,200	13.40	32,600	4.70	29,500	15.60	21,500	3.40
036	PSC	36,900	14.30	38,800	4.65	38,500	16.65	27,100	3.55
042	PSC	39,600	13.65	42,800	4.45	41,200	15.90	30,000	3.25
048	PSC	46,200	13.95	58,600	4.65	48,400	16.35	39,300	3.40
041	ECM	37,000	14.35	38,200	4.70	38,400	16.45	26,500	3.45
060	ECM	59,000	14.30	66,400	4.30	61,100	16.40	46,200	3.30
070	ECM	65,200	14.60	71,800	4.60	67,600	16.60	50,000	3.50

# Greensource i Series Model SV

## Water Source Heat Pump ½ to 6 Ton



# BOSCH

Physical Data								
Description	Unit	Value						
		SV007	SV009	SV012	SV015	SV018	SV024	SV030
Compressor Type (Qty 1)	–	Rotary	Rotary	Rotary	Rotary	Rotary	Scroll	Scroll
Max Water Working Pressure	PSIG/kPa	400	400	400	400	400	400	400
<b>PSC Fan Motor &amp; Blower</b>								
Fan Motor Type/Speeds	–	PSC/3	PSC/3	PSC/3	PSC/3	PSC/3	PSC/3	PSC/3
Fan Motor	HP	1/10	1/10	1/10	1/6	1/4	1/4	1/4
Blower Wheel Size	Inch (Dia. x W)	4.5 x 4.5	4.5 x 4.5	5.5 x 4.5	9 x 7	9 x 7	9 x 7	9 x 7
<b>ECM Fan Motor &amp; Blower</b>								
Fan Motor Type/Speeds	–	N/A	N/A	N/A	N/A	N/A	N/A	N/A
Fan Motor	HP	N/A	N/A	N/A	N/A	N/A	N/A	N/A
Blower Wheel Size	Inch (Dia. x W)	N/A	N/A	N/A	N/A	N/A	N/A	N/A
<b>Water Connection Size</b>								
FPT	Inch	¾	¾	¾	¾	¾	¾	¾
Coaxial Coil Volume	Gal	0.04	0.06 (Cu) 0.08 (CuNi)	0.08	0.09	0.14	0.24	0.24
<b>Vertical Cabinet</b>								
Refrigeration Charge	Oz	16	15	21	19 (Cu) 19 (CuNi) -Captube) 17 (CuNi)	22	35 (Cu) 33 (CuNi)	35 (Cu) 33 (CuNi)
Air Coil Dimensions	Inch (H x W)	10 x 14	10 x 14	10 x 14	12 x 16.5	16 x 16.5	20 x 16.5	20 x 16.5
Standard Filter - 1"	Inch (L x H)	10 x 16	10 x 16	10 x 16	16 x 20	16 x 20	20 x 20	20 x 20
Optional Filter - 2" MERV 7 or 13	Inch (L x H)	10 x 16	10 x 16	10 x 16	16 x 20	16 x 20	20 x 20	20 x 20
Weight - Operating	lbs	98	103	105	123	173	177	190
Weight - Shipping	lbs	126	130	132	151	201	205	217
<b>Horizontal Cabinet</b>								
Refrigeration Charge	Oz	16	16 (Cu) 19 (CuNi)	19	19	22	35 (Cu) 33 (CuNi)	35 (Cu) 33 (CuNi)
Air Coil Dimensions	Inch (H x W)	10 x 14	10 x 14	10 x 14	12 x 16.5	16 x 16.5	16 x 20.5	16 x 20.5
Standard Filter - 1"	Inch (L x H)	10 x 16	10 x 16	10 x 16	16 x 20	16 x 20	16 x 25	16 x 25
Optional Filter - 2" MERV 7 or 13	Inch (L x H)	10 x 16	10 x 16	10 x 16	16 x 20	16 x 20	16 x 25	16 x 25
Weight - Operating	lbs	96	100	105	136	174	181	190
Weight - Shipping	lbs	128	132	134	158	208	212	224

# Greensource i Series Model SV

## Water Source Heat Pump ½ to 6 Ton



# BOSCH

Physical Data							
Description	Unit	Value					
		SV036	SV041	SV042	SV048	SV060	SV070
Compressor Type (Qty 1)	—	Scroll	Scroll	Scroll	Scroll	Scroll	Scroll
Max Water Working Pressure	PSIG/kPa	400	400	400	400	400	400
<b>PSC Fan Motor &amp; Blower</b>							
Fan Motor Type/Speeds	—	PSC/3	N/A	PSC/3	PSC/3	N/A	N/A
Fan Motor	HP	1/2	N/A	1/2	3/4	N/A	N/A
Blower Wheel Size	Inch (Dia. x W)	9 x 7	N/A	10 x 8	10 x 8	N/A	N/A
<b>ECM Fan Motor &amp; Blower</b>							
Fan Motor Type/Speeds	—	N/A	X13	N/A	N/A	X13	X13
Fan Motor	HP	N/A	3/4	N/A	N/A	1.0	1.0
Blower Wheel Size	Inch (Dia. x W)	N/A	10 x 8	N/A	N/A	11 x 9	11 x 9
<b>Water Connection Size</b>							
FPT	Inch	¾	¾	¾	1	1	1
Coaxial Coil Volume	Gal	0.27	0.27	0.27	0.49	0.62	0.62
<b>Vertical Cabinet</b>							
Refrigeration Charge	Oz	44 (Cu) 40 (CuNi)	38	43 (Cu) 42 (CuNi)	52	59	73
Air Coil Dimensions	Inch (H x W)	24x20.2	20x16	24x20.2	24x26.75	24x26.75	32x26.2
Standard Filter - 1"	Inch (L x H)	24x24	20x20	24x24	24x30	24x30	16x30 @2
Optional Filter - 2" MERV 7 or 13	Inch (L x H)	24x24	20x20	24x24	24x30	24x30	16x30 @2
Weight - Operating	lbs	229	217	239	287	307	336
Weight - Shipping	lbs	255	243	265	312	331	360
<b>Horizontal Cabinet</b>							
Refrigeration Charge	Oz	40 (Cu) 40 (CuNi)	N/A	43 (Cu) 39 (CuNi)	51	70	61
Air Coil Dimensions	Inch (H x W)	18x27.5	N/A	18x27.5	20x32	20x32	20x42
Standard Filter - 1"	Inch (L x H)	18x30	N/A	18x30	20x34.5	20x34.5	20x24 @2
Optional Filter - 2" MERV 7 or 13	Inch (L x H)	18x30	N/A	18x30	20x34.5	20x34.5	20x24 @2
Weight - Operating	lbs	236	N/A	231	274	288	316
Weight - Shipping	lbs	270	N/A	264	299	318	365

**Greensource** i Series Model SV  
Water Source Heat Pump ½ to 6 Ton



**BOSCH**

Operating Limits - Cooling & Heating	
Description	Standard Unit
<b>COOLING</b>	
Minimum evaporator entering air db/wb °F	68/57
Rated air coil entering air db/wb °F	80/67
Maximum evaporator entering air db/wb °F	95/85
Minimum water coil entering fluid temperature °F	50
Water loop typical coil entering fluid range temperature °F	70/90
Maximum water coil entering fluid temperature °F	110
<b>HEATING</b>	
Minimum evaporator entering air db °F	50
Rated air coil entering air °F	68
Maximum evaporator entering air db °F	80
Normal water coil entering fluid range °F	25-80*
Minimum water coil entering Fluid °F	20*

\* antifreeze solution is required at these fluid temperatures.



**Units are designed to be installed in an air conditioned space. Maximum and minimum conditions may not be combined. Should one value be at the maximum or minimum, the other can not exceed the normal condition. Maximum and minimum conditions are at rated flow rates.**

**GreenSource** i Series Model SV  
Water Source Heat Pump ½ to 6 Ton



**BOSCH**

Horizontal Cabinet Corner Weights										
Configuration			Left Hand Evaporator				Right Hand Evaporator			
Model	Unit	Total	Left Front*	Right Front*	Left Back	Right Back	Left Front*	Right Front*	Left Back	Right Back
SVH 007	Lbs	98	28	21	25	24	21	28	24	25
	kg	45	13	10	11	11	10	13	11	11
SVH 009	Lbs	103	29	23	26	25	23	29	25	26
	kg	47	13	10	12	11	10	13	11	12
SVH 012	Lbs	105	29	24	26	26	24	29	26	26
	kg	48	13	11	12	12	11	13	12	12
SVH 015	Lbs	127	36	28	34	29	28	36	29	34
	kg	58	16	13	15	13	13	16	13	15
SVH 018	Lbs	177	57	36	48	37	36	57	37	48
	kg	80	26	16	22	17	16	26	17	22
SVH 024	Lbs	181	58	37	48	38	37	58	38	48
	kg	82	26	17	22	17	17	26	17	22
SVH 030	Lbs	194	61	41	52	41	41	61	41	52
	kg	88	28	18	23	19	18	28	19	23
SVH 036	Lbs	237	71	49	66	52	49	71	52	66
	kg	108	32	22	30	24	22	32	24	30
SVH 042	Lbs	231	70	47	64	50	47	70	50	64
	kg	105	32	21	29	23	21	32	23	29
SVH 048	Lbs	268	87	60	62	60	60	87	60	62
	kg	122	39	27	28	27	27	39	27	28
SVH 060	Lbs	288	88	65	69	66	65	88	66	69
	kg	131	40	29	31	30	29	40	30	31
SVH 070	Lbs	316	98	72	76	70	72	98	70	76
	kg	143	44	32	35	32	32	44	32	35

\*Front is control box end

**Greensource** i Series Model SV  
Water Source Heat Pump ½ to 6 Ton



**BOSCH**

Electrical Data - PSC Standard Blower Motor											
Model	Voltage Code	Voltage/Hz/Phase	Voltage Min/Max	Compressor			Blower Motor			Single Point Power	
				QTY	RLA	LRA	FLA	HP	Total Unit FLA	Min. Circuit Amps	MOP
SV007	1	208-230/1/60	197/253	1	2.6	17.7	0.96	0.1	3.6	4.2	15
SV009	1	208-230/1/60	197/253	1	3.4	22.2	0.96	0.1	4.4	5.2	15
SV012	1	208-230/1/60	197/253	1	4.6	28.0	0.96	0.1	5.6	6.7	15
SV015	1	208-230/1/60	197/253	1	5.6	29.0	1.10	1.17	6.7	8.1	15
SV018	1	208-230/1/60	197/253	1	7.4	33	1.8	0.25	9.2	11.1	15
SV024	1	208-230/1/60	197/253	1	13.5	58.3	1.8	0.25	15.3	18.7	30
SV030	1	208-230/1/60	197/253	1	12.8	64	1.8	0.25	14.6	17.8	30
SV036	1	208-230/1/60	197/253	1	15.2	79	4.4	0.5	19.6	23.4	35
SV042	1	208-230/1/60	197/253	1	16.1	109	4.4	0.5	20.5	24.5	40
SV048	1	208-230/1/60	197/253	1	19.6	130	4.4	0.75	24.0	28.9	45

Electrical Data - Constant Torque ECM											
Model	Voltage Code	Voltage/Hz/Phase	Voltage Min/Max	Compressor			Blower Motor			Single Point Power	
				QTY	RLA	LRA	FLA	HP	Total Unit FLA	Min Circuit Amps	MOP
SV041	1	208-230/1/60	197/253	1	15.4	83.9	6.0	0.75	21.4	25.3	40
SV060	1	208-230/1/60	197/253	1	26.3	145	7.6	1.00	33.9	40.5	60
SV070	1	208-230/1/60	197/253	1	28.3	158	7.6	1.00	35.9	43.0	70



# Greensource i Series Model SV

## Water Source Heat Pump ½ to 6 Ton



# BOSCH

Blower Performance CFM (PSC Standard Motor Blower)														
Model	Available External Static Pressure (in. wc. Wet coil and filter included)													
	Motor Speed	Rated Airflow	0.10	0.20	0.30	0.40	0.50	0.60	0.70	0.80	0.90	1.00	1.10	1.20
SV007	Low		370	340	295	250	-	-	-	-	-	-	-	-
	Medium	300	390	360	330	300	260	-	-	-	-	-	-	-
	High		410	380	350	315	280	210	-	-	-	-	-	-
SV009	Low		370	340	295	250	-	-	-	-	-	-	-	-
	Medium		390	360	330	300	260	-	-	-	-	-	-	-
	High	350	410	380	350	315	280	210	-	-	-	-	-	-
SV012	Low		300	290	290	300	-	-	-	-	-	-	-	-
	Medium		380	380	360	330	290	-	-	-	-	-	-	-
	High	400	420	400	380	360	340	320	-	-	-	-	-	-
SV015	Low		500	450	400	-	-	-	-	-	-	-	-	-
	Medium		560	520	480	430	400	-	-	-	-	-	-	-
	High	500	700	650	600	550	500	450	400	-	-	-	-	-
SV018	Low		630	590	560	-	-	-	-	-	-	-	-	-
	Medium	600	810	790	760	730	680	590	-	-	-	-	-	-
	High		1010	970	920	870	800	680	530	-	-	-	-	-
SV024	Low		740	730	700	660	610	-	-	-	-	-	-	-
	Medium		830	810	770	730	680	620	-	-	-	-	-	-
	High	800	1000	950	900	830	750	690	630	-	-	-	-	-
SV030	Low		740	730	700	660	610	-	-	-	-	-	-	-
	Medium		830	810	770	730	680	620	-	-	-	-	-	-
	High	950	1000	950	900	830	750	690	630	-	-	-	-	-
SV036	Low		1290	1250	1200	1150	1080	1000	-	-	-	-	-	-
	Medium		1410	1350	1290	1220	1150	1060	900	-	-	-	-	-
	High	1200	1500	1440	1370	1290	1210	1120	1000	900	-	-	-	-
SV042	Low		1210	1210	1190	1160	1120	1080	-	-	-	-	-	-
	Medium		1460	1450	1430	1390	1330	1250	1160	-	-	-	-	-
	High	1400	1750	1710	1670	1620	1560	1460	1330	1210	1080	-	-	-
SV048 208/230V	Low		1450	1440	1420	1400	1360	1320	-	-	-	-	-	-
	Med		1700	1670	1630	1580	1530	1470	1400	-	-	-	-	-
	Hi	1600	1930	1870	1810	1740	1670	1600	1520	1430	1340	-	-	-
SV048 460V	Low		1886	1853	1818	1773	1724	1654	1562	1481	1386	1299	883	-
	Med		2029	1993	1946	1897	1837	1763	1662	1564	1460	1360	1254	-
	Hi	1600	2225	2170	2105	2032	1961	1885	1793	1666	1541	1435	1298	-

Blower Performance Constant Torque ECM														
Model	Fan Speed	Rated Airflow	Available External Static Pressure (in. wc. Wet coil and filter included)											
			0.10	0.20	0.30	0.40	0.50	0.60	0.70	0.80	0.90	1.00	1.10	1.20
SV041	1		840	770	700	620	-	-	-	-	-	-	-	-
	2		1220	1150	1080	1010	950	-	-	-	-	-	-	-
	3		1430	1360	1280	1200	1130	1080	-	-	-	-	-	-
	4	1250	1540	1460	1380	1300	1220	1140	1060	-	-	-	-	-
	5		1620	1550	1470	1370	1260	1180	1090	1000	-	-	-	-
SV060	1		1900	1880	1860	1820	-	-	-	-	-	-	-	-
	2		2000	1970	1950	1920	1890	1860	-	-	-	-	-	-
	3	2000	2110	2090	2060	2030	2010	1970	1940	1910	1880	-	-	-
	4		2220	2200	2170	2140	2110	2080	2050	2060	2050	2000	1920	-
	5		2340	2320	2290	2260	2230	2210	2180	2150	2110	2070	2000	1930
SV070	1		2050	2010	1970	1930	-	-	-	-	-	-	-	-
	2		2150	2120	2080	2030	1990	1960	-	-	-	-	-	-
	3	2100	2270	2230	2200	2160	2120	2080	2040	2010	1980	-	-	-
	4		2390	2350	2320	2280	2250	2200	2160	2130	2100	2070	2030	-
	5		2520	2480	2450	2420	2380	2330	2290	2260	2220	2170	2100	2020

**GreenSource** i Series Model SV  
Water Source Heat Pump ½ to 6 Ton



**BOSCH**

Horizontal Cabinet Corner Weights										
Configuration			Left Hand Evaporator				Right Hand Evaporator			
Model	Unit	Total	Left Front*	Right Front*	Left Back	Right Back	Left Front*	Right Front*	Left Back	Right Back
SV 007	Lbs	98	28	21	25	24	21	28	24	25
	kg	45	13	10	11	11	10	13	11	11
SV 009	Lbs	103	29	23	26	25	23	29	25	26
	kg	47	13	10	12	11	10	13	11	12
SV 012	Lbs	105	29	24	26	26	24	29	26	26
	kg	48	13	11	12	12	11	13	12	12
SV 015	Lbs	127	36	28	34	29	28	36	29	34
	kg	58	16	13	15	13	13	16	13	15
SV 018	Lbs	177	57	36	48	37	36	57	37	48
	kg	80	26	16	22	17	16	26	17	22
SV 024	Lbs	181	58	37	48	38	37	58	38	48
	kg	82	26	17	22	17	17	26	17	22
SV 030	Lbs	194	61	41	52	41	41	61	41	52
	kg	88	28	18	23	19	18	28	19	23
SV 036	Lbs	237	71	49	66	52	49	71	52	66
	kg	108	32	22	30	24	22	32	24	30
SV 042	Lbs	231	70	47	64	50	47	70	50	64
	kg	105	32	21	29	23	21	32	23	29
SV 048	Lbs	268	87	60	62	60	60	87	60	62
	kg	122	39	27	28	27	27	39	27	28
SV 060	Lbs	288	88	65	69	66	65	88	66	69
	kg	131	40	29	31	30	29	40	30	31
SV 070	Lbs	316	98	72	76	70	72	98	70	76
	kg	143	44	32	35	32	32	44	32	35

**Vertical Unit Configurations**

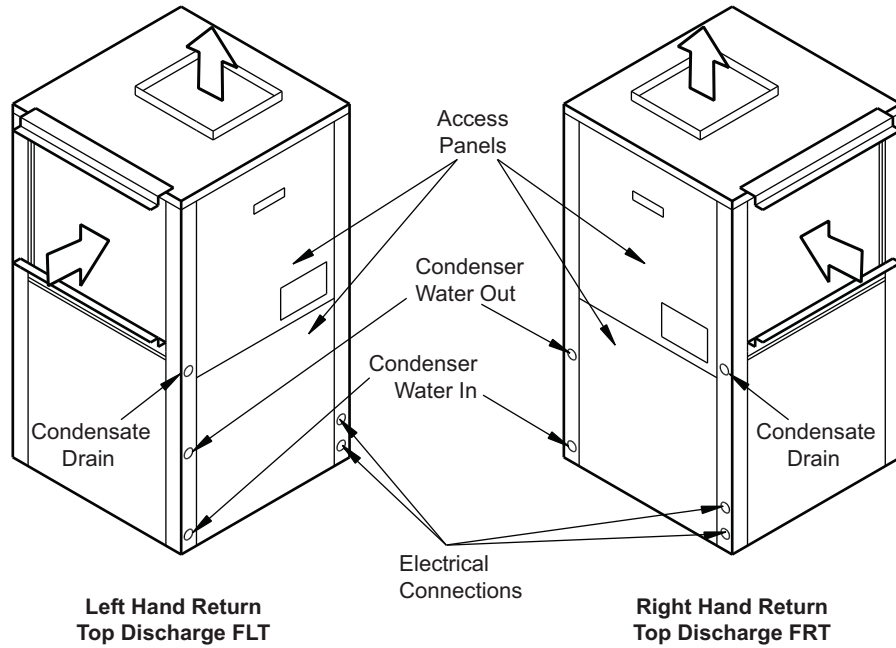

**Horizontal Unit Configurations**

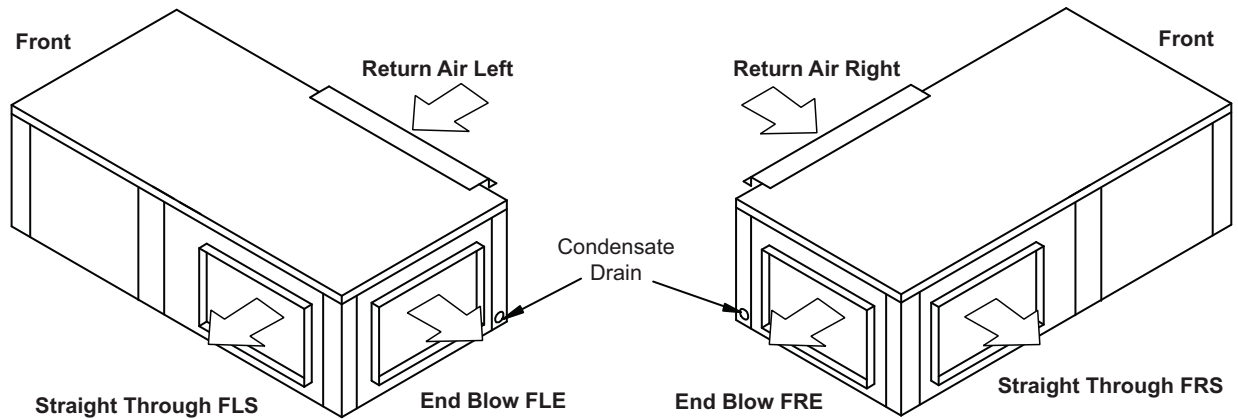

# Greensource i Series Model SV

## Water Source Heat Pump 1/2 to 6 Ton



### SV Vertical Unit Dimensions and Connections

MODEL	A		B	C	D	E	F	G	H	J	K	M	N	P	Q	Condenser Water Connections	Recommended Standard Replacement Nominal Filter Size
	Width	Depth	Height	Discharge Depth	Discharge Width	Cabinet edge to Discharge	Left side to Discharge	Water Inlet	Water Outlet	Condensate Drain	R/A Duct Fig Width	R/A Duct Fig Height	Filter Rack				
SV007	19	19	24.25	10	8	4.5	9.5	2.44	9.68	13.87	16	8	10	5.6	3/4" F.P.T.	10x16x1	
SV009	19	19	24.25	10	8	4.5	9.5	2.44	9.68	13.87	16	8	10	5.6	3/4" F.P.T.	10x16x1	
SV012	19	19	24.25	10	8	4.5	9.5	2.44	9.68	13.87	16	8	10	5.6	3/4" F.P.T.	10x16x1	
SV015	21.5	21.5	32.25	10	8	5.75	12.1	2.85	8.45	15.87	20	14	16	8.1	3/4" F.P.T.	16x20x1	
SV018	21.5	21.5	32.25	14	14	3.6	4.8	2.85	8.45	15.87	20	14	16	4.8	3/4" F.P.T.	16x20x1	
SV024	21.5	21.5	39.25	14	14	3.6	4.8	2.8	14.95	18.87	20	18	20	4.8	3/4" F.P.T.	20x20x1	
SV030	21.5	21.5	39.25	14	14	3.6	4.8	2.8	14.95	18.87	20	18	20	4.8	3/4" F.P.T.	20x20x1	
SV036	21.5	26	44.25	15.5	14	6.5	4.2	2.75	10.77	18.87	24	22	24	4.2	3/4" F.P.T.	24x24x1	
SV041	21.5	21.5	39.25	15.5	14	2	4.2	2.8	14.95	18.87	20	18	20	4.2	3/4" F.P.T.	20x20x1	
SV042	21.5	26	44.25	15.5	14	6.5	4.2	2.75	10.77	18.87	24	22	24	4.2	3/4" F.P.T.	24x24x1	
SV048	24	32.5	45.25	18	14	10	6	3.26	13.2	20.87	30	22	24	6	1" F.P.T.	24x30x1	
SV060	24	32.5	45.25	18	14	10	6	3.26	13.2	20.87	30	22	24	6	1" F.P.T.	24x30x1	
SV070	26	33.25	58.25	18	15.5	10.8	7	2.92	13.36	25.87	30	30	32	7	1" F.P.T.	16x30x1 (2)	

Return Air (Filter) View

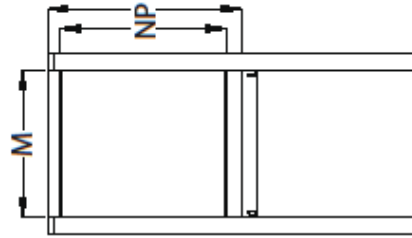

Right Hand Return (FRT)

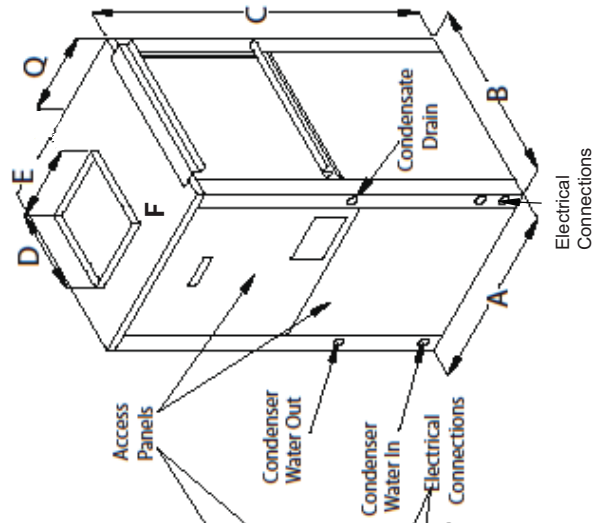

Left Hand Return (FLT)

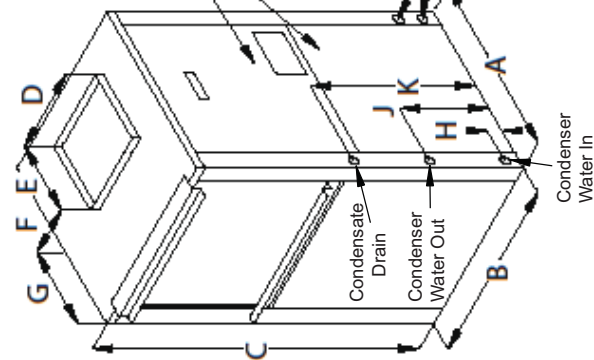

NOTE: All dimensions within + - 0.125". All condensate drain connections are 3/4" FPT. Specifications subject to change without notice.

# Greensource i Series Model SV

## Water Source Heat Pump 1/2 to 6 Ton



### SV Horizontal Unit Dimensions and Connections

Model	A Width	B Depth	C Height	D Cabinet End to Filter Rack	E R/A Duct Width	F Cab Front to Filter Rack	d "Water Inlet"	H "Water Outlet"	J Side to Discharge (End)	K "Discharge Width"	M Top to Discharge (FLE & FRS)	N "Discharge Height"	P End to Discharge (Straight)	Q Top to Discharge (FRE & FLS)	R Filter Rack Height	T R/A Duct Flange Height	Condens- er Water Connec- tions	Recommended Replacement Nominal Filter Size
SV009	19.0	33.0	11.5	1.5	16.15	15.35	2.38	9.5	5.375	6.3	5.97	4.1	4.875	1.41	11.3	8.6	3/4" FPT	10" x 16" x 1
SV012	19.0	33.0	11.5	1.5	16.15	15.35	2.38	9.5	5.25	6.43	6.31	4.1	4.75	1.14	11.3	8.6	3/4" FPT	10" x 16" x 1
SV015	22.0	43.0	17.0	1.5	20.15	21.35	2.86	15.0	5.42	9.13	6.11	9.65	4.92	1.23	16.8	15.0	3/4" FPT	16" x 20" x 1
SV018	22.0	43.0	17.0	1.5	20.15	21.35	2.86	14.13	5.42	9.13	6.11	9.65	4.92	1.23	16.8	15.0	3/4" FPT	16" x 20" x 1
SV024	22.0	43.0	17.0	1.5	25.0	16.5	2.86	14.13	5.42	9.13	6.11	9.65	4.92	1.23	16.8	15.0	3/4" FPT	16" x 25" x 1
SV030	22.0	43.0	17.0	1.5	25.0	16.5	2.47	15.0	5.42	9.13	6.11	9.65	4.92	1.23	16.8	15.0	3/4" FPT	16" x 25" x 1
SV036	22.0	54.5	19.0	1.5	30.15	22.85	2.86	16.13	6.47	9.13	7.5	10.28	5.97	1.21	18.8	17.0	3/4" FPT	18" x 30" x 1
SV042	22.0	54.5	19.0	1.5	30.15	22.85	2.86	16.13	5.27	10.45	6.46	11.3	4.77	1.22	18.8	17.0	3/4" FPT	18" x 30" x 1
SV048	25.0	54.5	21.0	1.5	34.6	18.4	2.86	18.52	7.25	10.45	7.46	11.36	6.75	2.16	20.8	19.0	1" FPT	20" x 34.5" x 5" x 1
SV060	25.0	54.5	21.0	1.5	34.6	18.4	2.86	18.52	6.32	11.76	6.81	12.5	5.82	1.68	20.8	19.0	1" FPT	20" x 34.5" x 5" x 1
SV070	25.0	65.0	21.0	1.5	48.1	15.4	2.86	18.52	6.32	11.76	6.81	12.5	5.82	1.68	20.8	19.0	1" FPT	20" x 24" x 1 (2)

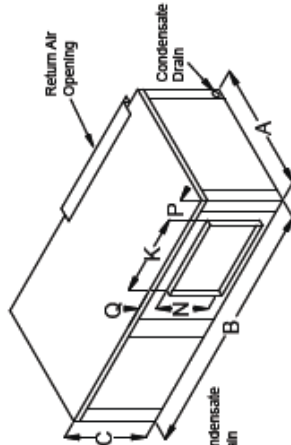

**Left Hand Return  
Straight Through (FLS)**

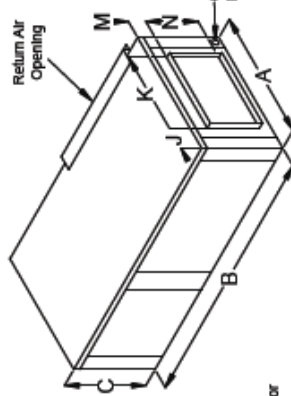

**Left Hand Return End Blow (FLE)**

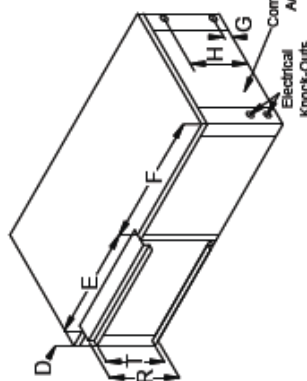

**Right Hand Return End Blow (FRE)**

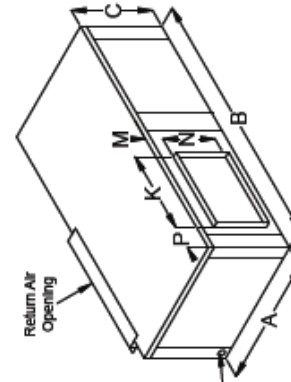

**Right Hand Return  
Straight Through (FRS)**

**NOTE:** Models SV048 & 060 Left Hand Return units have condenser water connections on the front right and electrical knockouts on the front left.

**NOTE:** All dimensions within ± 0.125". All condensate drain connections are 3/4" FPT. Specifications subject to change without notice.

# Greensource i Series Model SV

## Water Source Heat Pump 1/2 to 6 Ton



### SV007 (300 CFM) Capacity Data

COOLING										HEATING				
Entering Fluid Temp (F)	Water Flow (GPM)	Pressure Drop PSI (FOH)	Entering Air Temp (db/wb) F	Total Capacity (MBTUH)	Sensible Capacity (MBTUH)	Heat of Rejection (MBTUH)	Power Input (kW)	EER	Entering Fluid Temp (F)	Entering Air Temp (F)	Total Capacity (MBTUH)	Heat of Absorption (MBTUH)	Power Input (kW)	COP
50	1	0.3 (0.6)	75/63	7.0	6.3	8.3	0.42	16.9	30*	60	4.5	3.2	0.42	3.1
			80/67	7.5	6.5	8.8	0.42	18.1		70	4.4	3.0	0.45	2.8
			85/71	7.9	6.7	9.2	0.42	19.0		80	4.3	2.8	0.48	2.6
	2	1.2 (2.77)	75/63	7.5	6.5	8.6	0.37	20.3		60	4.9	3.6	0.43	3.3
			80/67	8.0	6.7	9.1	0.37	21.9		70	4.8	3.4	0.46	3.0
			85/71	8.5	6.9	9.7	0.36	23.5		80	4.6	3.1	0.49	2.7
	3	2.5 (5.77)	75/63	7.6	6.5	8.8	0.35	21.6		60	5.1	3.8	0.43	3.4
			80/67	8.1	6.8	9.3	0.35	23.4		70	5.0	3.5	0.46	3.2
			85/71	8.7	7.0	9.8	0.34	25.5		80	4.8	3.2	0.49	2.8
60	1	0.3 (0.6)	75/63	6.6	6.1	8.0	0.45	14.6	40*	60	5.3	3.9	0.43	3.6
			80/67	7.1	6.3	8.5	0.46	15.7		70	5.1	3.7	0.46	3.2
			85/71	7.5	6.6	8.9	0.46	16.5		80	5.0	3.4	0.50	2.9
	2	1.2 (2.77)	75/63	7.1	6.3	8.3	0.41	17.4		60	5.8	4.4	0.44	3.9
			80/67	7.5	6.5	8.8	0.41	18.4		70	5.6	4.1	0.47	3.5
			85/71	8.0	6.8	9.3	0.41	19.8		80	5.4	3.8	0.50	3.1
	3	2.4 (5.54)	75/63	7.2	6.4	8.5	0.40	18.3		60	6.0	4.6	0.44	4.0
			80/67	7.7	6.6	9.0	0.39	19.8		70	5.8	4.3	0.47	3.6
			85/71	8.2	6.8	9.5	0.39	21.3		80	5.6	4.0	0.51	3.2
70	1	0.3 (0.6)	75/63	6.2	6.0	7.7	0.49	12.7	50	60	6.0	4.7	0.44	4.0
			80/67	6.7	6.2	8.2	0.50	13.6		70	5.9	4.4	0.47	3.6
			85/71	7.1	6.5	8.6	0.50	14.3		80	5.7	4.1	0.51	3.3
	2	1.1 (2.54)	75/63	6.6	6.1	8.0	0.45	14.7		60	6.7	5.3	0.44	4.4
			80/67	7.1	6.4	8.5	0.45	15.8		70	6.5	4.9	0.48	4.0
			85/71	7.6	6.6	9.0	0.45	17.0		80	6.3	4.6	0.52	3.6
	3	2.3 (5.31)	75/63	6.8	6.2	8.1	0.44	15.6		60	6.9	5.5	0.44	4.5
			80/67	7.3	6.4	8.6	0.44	16.8		70	6.7	5.2	0.48	4.1
			85/71	7.8	6.7	9.1	0.43	18.1		80	6.5	4.8	0.52	3.7
80	1	0.3 (0.6)	75/63	5.9	5.6	7.4	0.53	11.2	60	60	6.9	5.5	0.44	4.5
			80/67	6.3	6.1	7.8	0.54	11.8		70	6.7	5.2	0.48	4.1
			85/71	6.7	6.3	8.3	0.54	12.5		80	6.5	4.9	0.52	3.7
	2	1.1 (2.54)	75/63	6.2	6.0	7.7	0.50	12.6		60	7.6	6.2	0.45	5.0
			80/67	6.7	6.2	8.2	0.50	13.6		70	7.4	5.8	0.49	4.4
			85/71	7.1	6.5	8.6	0.50	14.4		80	7.1	5.4	0.53	3.9
	3	2.3 (5.31)	75/63	6.4	6.0	7.8	0.48	13.4		60	7.9	6.5	0.45	5.2
			80/67	6.8	6.3	8.3	0.48	14.2		70	7.7	6.1	0.49	4.6
			85/71	7.3	6.5	8.7	0.48	15.3		80	7.4	5.7	0.53	4.1
85	1	0.3 (0.6)	75/63	5.7	5.5	7.3	0.55	10.4	70	60	7.7	6.3	0.45	5.0
			80/67	6.1	5.8	7.7	0.56	11.0		70	7.6	6.0	0.49	4.6
			85/71	6.4	6.3	8.1	0.56	11.5		80	7.4	5.6	0.53	4.1
	2	1.1 (2.54)	75/63	6.0	5.7	7.6	0.52	11.7		60	8.6	7.2	0.45	5.6
			80/67	6.4	6.1	8.0	0.52	12.4		70	8.3	6.8	0.49	4.9
			85/71	6.9	6.4	8.4	0.52	13.4		80	8.1	6.3	0.53	4.4
	3	2.2 (5.07)	75/63	6.1	5.9	7.6	0.50	12.2		60	9.0	7.6	0.45	5.9
			80/67	6.6	6.2	8.1	0.50	13.2		70	8.7	7.1	0.49	5.2
			85/71	7.0	6.4	8.6	0.50	14.0		80	8.4	6.6	0.53	4.6
90	1	0.3 (0.6)	75/63	5.5	5.4	7.1	0.57	9.7	80	60	8.6	7.2	0.45	5.6
			80/67	5.9	5.7	7.5	0.58	10.3		70	8.4	6.9	0.49	5.0
			85/71	6.2	6.0	8.0	0.58	10.7		80	8.2	6.5	0.53	4.5
	2	1.1 (2.54)	75/63	5.8	5.6	7.4	0.54	10.8		60	9.6	8.2	0.45	6.3
			80/67	6.2	6.0	7.8	0.54	11.6		70	9.3	7.7	0.49	5.5
			85/71	6.6	6.3	8.3	0.54	12.3		80	9.0	7.3	0.54	4.9
	3	2.2 (5.07)	75/63	5.9	5.7	7.5	0.53	11.3		60	10.0	8.6	0.45	6.5
			80/67	6.3	6.1	7.9	0.53	12.0		70	9.7	8.1	0.49	5.8
			85/71	6.8	6.4	8.4	0.53	13.0		80	9.3	7.6	0.54	5.0
100	1	0.3 (0.6)	75/63	5.1	5.1	6.9	0.62	8.4	* Extended Range - Anti-freeze required					
			80/67	5.4	5.4	7.2	0.62	8.8		▶ AHRI/ISO13256-1 certified performance is rated at entering air conditions of 80.6°F DB and 66.2°F WB in cooling and 68°F DB in heating.				
			85/71	5.8	5.8	7.6	0.63	9.3		▶ Tabulated unit performance does not include fan or pump power corrections required for AHRI/ISO standard performance ratings.				
	2	1 (2.31)	75/63	5.4	5.4	7.1	0.58	9.3		▶ Unit performance may be interpolated. Extrapolation is not allowed.				
			80/67	5.8	5.7	7.5	0.59	10.0		▶ For conditions other than rating conditions provided, consult the FHP BST selection software.				
			85/71	6.2	5.9	7.9	0.59	10.6		▶ Ratings below 40°F are with a methanol solution.				
	3	2.1 (4.84)	75/63	5.5	5.4	7.1	0.57	9.7		▶ The results reported herein are estimates based on testing by FHP. Variations in the installation and operational environment may alter performance. Bosch disclaims all warranties, express and implied, that the performance will be as reported, including the warranty of merchantability and fitness for purpose. In addition, continuous research and development may result in a change to an appliances design and specifications, which Bosch may change without notice. Before purchase, confirm the design specifications of the appliance.				
			80/67	5.9	5.7	7.6	0.58	10.3		▶ Continuous research and development to improve our products may result in a change				
			85/71	6.3	6.0	8.0	0.58	11.0		Bosch Thermotechnology Corp.				
110	1	0.3 (0.6)	75/63	4.7	4.7	6.6	0.66	7.2	Watertown, MA • Londonderry, NH • Ft. Lauderdale, FL					
			80/67	5.0	5.0	7.0	0.67	7.5						
			85/71	5.4	5.4	7.3	0.68	8.0						
	2	1 (2.31)	75/63	5.0	5.0	6.8	0.63	8.0						
			80/67	5.3	5.3	7.2	0.64	8.4						
			85/71	5.7	5.7	7.6	0.64	9.0						
	3	2.1 (4.84)	75/63	5.1	5.1	6.8	0.62	8.3						
			80/67	5.4	5.4	7.2	0.62	8.7						
			85/71	5.8	5.8	7.6	0.63	9.3						

# Greensource i Series Model SV

## Water Source Heat Pump ½ to 6 Ton



### SV009 (350 CFM) Capacity Data

COOLING										HEATING				
Entering Fluid Temp (F)	Water Flow (GPM)	Pressure Drop PSI (FOH)	Entering Air Temp (db/wb) F	Total Capacity (MBTUH)	Sensible Capacity (MBTUH)	Heat of Rejection (MBTUH)	Power Input (kW)	EER	Entering Fluid Temp (F)	Entering Air Temp (F)	Total Capacity (MBTUH)	Heat of Absorption (MBTUH)	Power Input (kW)	COP
50	1	0.5 (1.1)	75/63	9.1	7.7	10.6	0.52	17.6	30*	60	5.8	4.2	0.54	3.1
			80/67	9.6	8	11.2	0.52	18.6		70	5.7	3.9	0.58	2.9
			85/71	10.2	8.2	11.8	0.52	19.8		80	5.6	3.7	0.63	2.6
	2	1.8 (4.15)	75/63	9.6	8	11	0.44	21.6		60	6.4	4.7	0.55	3.4
			80/67	10.3	8.2	11.7	0.44	23.6		70	6.3	4.4	0.59	3.1
			85/71	10.9	8.5	12.3	0.43	25.4		80	6.1	4.1	0.64	2.8
	3	3.8 (8.77)	75/63	9.8	8	11.1	0.42	23.5		60	6.7	5	0.55	3.6
			80/67	10.5	8.3	11.8	0.41	25.7		70	6.5	4.6	0.6	3.2
			85/71	11.2	8.6	12.5	0.4	28.2		80	6.4	4.3	0.64	2.9
60	1	0.5 (1.1)	75/63	8.6	7.5	10.4	0.57	15.1	40*	60	6.8	5.1	0.55	3.6
			80/67	9.2	7.8	10.9	0.57	16.1		70	6.7	4.8	0.6	3.3
			85/71	9.7	8.1	11.5	0.57	16.9		80	6.5	4.5	0.65	2.9
	2	1.8 (4.15)	75/63	9.2	7.8	10.7	0.5	18.3		60	7.5	5.7	0.56	3.9
			80/67	9.8	8	11.3	0.5	19.7		70	7.3	5.4	0.61	3.5
			85/71	10.4	8.3	11.9	0.49	21.2		80	7.1	5	0.66	3.2
	3	3.6 (8.30)	75/63	9.4	7.8	10.8	0.48	19.7		60	7.8	6	0.57	4.1
			80/67	10	8.1	11.5	0.47	21.2		70	7.6	5.6	0.61	3.6
			85/71	10.6	8.4	12.1	0.46	22.9		80	7.4	5.2	0.67	3.3
70	1	0.5 (1.1)	75/63	8.2	7.2	10	0.62	13.1	50	60	7.7	6	0.57	4
			80/67	8.7	7.6	10.6	0.63	13.8		70	7.6	5.7	0.61	3.6
			85/71	9.3	7.9	11.2	0.63	14.7		80	7.5	5.3	0.67	3.3
	2	1.7 (3.92)	75/63	8.7	7.5	10.4	0.56	15.5		60	8.6	6.8	0.57	4.4
			80/67	9.3	7.9	11	0.56	16.6		70	8.4	6.4	0.62	4
			85/71	9.9	8.1	11.6	0.56	17.8		80	8.2	6	0.68	3.6
	3	3.5 (8.07)	75/63	8.9	7.6	10.5	0.54	16.5		60	9	7.2	0.57	4.6
			80/67	9.5	7.9	11.1	0.53	17.8		70	8.7	6.7	0.63	4.1
			85/71	10.1	8.2	11.8	0.53	19.1		80	8.5	6.3	0.68	3.7
80	1	0.5 (1.1)	75/63	7.7	7	9.7	0.68	11.3	60	60	8.8	7	0.57	4.5
			80/67	8.2	7.3	10.3	0.69	11.9		70	8.6	6.6	0.63	4
			85/71	8.7	7.5	10.8	0.69	12.6		80	8.5	6.2	0.68	3.7
	2	1.6 (3.69)	75/63	8.2	7.2	10.1	0.62	13.2		60	9.8	8	0.58	5
			80/67	8.8	7.6	10.6	0.62	14.1		70	9.5	7.5	0.63	4.4
			85/71	9.3	7.9	11.2	0.62	15		80	9.3	7	0.69	3.9
	3	3.4 (7.61)	75/63	8.4	7.2	10.2	0.6	14		60	10.2	8.4	0.58	5.2
			80/67	9	7.7	10.8	0.6	15		70	9.9	7.8	0.64	4.6
			85/71	9.6	8	11.4	0.6	16.1		80	9.6	7.3	0.7	4.1
85	1	0.5 (1.1)	75/63	7.5	6.9	9.6	0.71	10.6	70	60	9.8	8	0.58	5
			80/67	8	7.2	10.1	0.72	11.2		70	9.6	7.6	0.63	4.4
			85/71	8.5	7.4	10.7	0.72	11.8		80	9.4	7.2	0.69	4
	2	1.6 (3.69)	75/63	8	7.1	9.9	0.65	12.2		60	11	9.2	0.58	5.6
			80/67	8.5	7.3	10.5	0.65	13		70	10.7	8.6	0.64	4.9
			85/71	9.1	7.8	11	0.65	13.9		80	10.4	8.1	0.7	4.3
	3	3.3 (7.61)	75/63	8.1	7.1	10	0.63	12.8		60	11.6	9.7	0.58	5.9
			80/67	8.7	7.4	10.6	0.63	13.7		70	11.1	9	0.64	5.1
			85/71	9.3	7.9	11.2	0.63	14.8		80	10.8	8.5	0.71	4.5
90	1	0.5 (1.1)	75/63	7.3	6.7	9.4	0.74	9.9	80	60	10.9	9.1	0.58	5.5
			80/67	7.8	7	10	0.75	10.4		70	10.7	8.6	0.64	4.9
			85/71	8.2	7.3	10.5	0.75	10.9		80	10.4	8.2	0.7	4.3
	2	1.6 (3.69)	75/63	7.7	7	9.7	0.68	11.2		60	12.3	10.5	0.58	6.2
			80/67	8.2	7.3	10.3	0.69	11.9		70	11.8	9.8	0.65	5.4
			85/71	8.8	7.5	10.8	0.69	12.8		80	11.5	9.3	0.71	4.7
	3	3.3 (7.61)	75/63	7.8	7	9.8	0.67	11.7		60	12.9	11.1	0.58	6.5
			80/67	8.4	7.3	10.4	0.67	12.6		70	12.3	10.2	0.65	5.6
			85/71	9	7.8	11	0.66	13.6		80	12	9.8	0.72	4.9
100	1	0.4 (0.9)	75/63	6.8	6.5	9.1	0.8	8.5	70	* Extended Range - Anti-freeze required				
			80/67	7.2	6.8	9.6	0.81	8.9		▶ AHRI/ISO13256-1 certified performance is rated at entering air conditions of 80.6°F DB and 66.2°F WB in cooling and 68°F DB in heating.				
			85/71	7.7	7.1	10.1	0.82	9.4		▶ Tabulated unit performance does not include fan or pump power corrections required for AHRI/ISO standard performance ratings.				
	2	1.5 (3.47)	75/63	7.2	6.7	9.4	0.75	9.6		▶ Unit performance may be interpolated. Extrapolation is not allowed.				
			80/67	7.7	7.1	9.9	0.75	10.2		▶ For conditions other than rating conditions provided, consult the FHP BST selection software.				
			85/71	8.2	7.3	10.5	0.75	10.9		▶ Ratings below 40°F are with a methanol solution.				
	3	3.2 (7.39)	75/63	7.3	6.8	9.5	0.73	10		▶ The results reported herein are estimates based on testing by FHP. Variations in the installation and operational environment may alter performance. Bosch disclaims all warranties, express and implied, that the performance will be as reported, including the warranty of merchantability and fitness for purpose. In addition, continuous research and development may result in a change to an appliances design and specifications, which Bosch may change without notice. Before purchase, confirm the design specifications of the appliance.				
			80/67	7.9	7.1	10	0.73	10.8		▶ Continuous research and development by Bosch Thermotechnology Corp. change				
			85/71	8.4	7.3	10.6	0.73	11.4		Watertown, MA • Londonderry, NH • Ft. Lauderdale, FL				
110	1	0.4 (0.9)	75/63	6.3	6.3	8.8	0.86	7.3						
			80/67	6.7	6.6	9.3	0.87	7.7						
			85/71	7.2	6.9	9.8	0.88	8.1						
	2	1.5 (3.47)	75/63	6.7	6.5	9	0.82	8.2						
			80/67	7.1	6.8	9.6	0.82	8.6						
			85/71	7.6	7.1	10.1	0.83	9.2						
	3	3.1 (7.15)	75/63	6.8	6.6	9.1	0.8	8.5						
			80/67	7.3	6.9	9.6	0.8	9.1						
			85/71	7.8	7.2	10.2	0.81	9.7						

# Greensource i Series Model SV

## Water Source Heat Pump ½ to 6 Ton



### SV012 (400 CFM) Capacity Data

COOLING									HEATING					
Entering Fluid Temp (F)	Water Flow (GPM)	Pressure Drop PSI (FOH)	Entering Air Temp (db/wb) F	Total Capacity (MBTUH)	Sensible Capacity (MBTUH)	Heat of Rejection (MBTUH)	Power Input (kW)	EER	Entering Fluid Temp (F)	Entering Air Temp (F)	Total Capacity (MBTUH)	Heat of Absorption (MBTUH)	Power Input (kW)	COP
50	1.5	1.1 (2.54)	75/63	12.5	9.7	14.6	0.67	18.8	30*	60	8.2	5.8	0.75	3.2
			80/67	13.3	10	15.4	0.67	19.9		70	8	5.5	0.8	2.9
			85/71	14.1	10.2	16.3	0.67	21		80	7.9	5.1	0.86	2.7
	2.5	2.8 (6.46)	75/63	12.9	9.9	14.9	0.61	21.3		60	8.6	6.2	0.75	3.3
			80/67	13.8	10.2	15.8	0.6	22.9		70	8.4	5.9	0.81	3
			85/71	14.7	10.4	16.7	0.6	24.6		80	8.3	5.5	0.87	2.8
	3.5	5.1 (11.7)	75/63	13.1	10	15	0.58	22.6		60	9	6.5	0.76	3.5
			80/67	14	10.3	15.9	0.57	24.4		70	8.7	6.1	0.82	3.1
			85/71	15	10.6	16.9	0.57	26.6		80	8.5	5.6	0.87	2.8
60	1.5	1.1 (2.54)	75/63	11.9	9.4	14.2	0.74	16.1	40*	60	9.4	6.9	0.76	3.6
			80/67	12.7	9.7	15	0.75	17.1		70	9.2	6.5	0.83	3.3
			85/71	13.5	10	15.9	0.75	18		80	9	6.1	0.89	3
	2.5	2.7 (6.23)	75/63	12.3	9.6	14.5	0.69	18		60	9.9	7.5	0.77	3.8
			80/67	13.2	9.9	15.4	0.68	19.4		70	9.7	7	0.84	3.4
			85/71	14.1	10.2	16.3	0.68	20.8		80	9.5	6.6	0.9	3.1
	3.5	4.9 (11.2)	75/63	12.5	9.7	14.6	0.66	18.9		60	10.3	7.8	0.77	3.9
			80/67	13.4	10	15.5	0.66	20.5		70	10	7.3	0.84	3.5
			85/71	14.3	10.3	16.4	0.65	22		80	9.7	6.8	0.91	3.1
70	1.5	1 (2.3)	75/63	11.3	9.2	13.8	0.82	13.9	50	60	10.6	8.1	0.78	4
			80/67	12	9.5	14.6	0.82	14.6		70	10.4	7.7	0.85	3.6
			85/71	12.8	9.8	15.4	0.83	15.4		80	10.2	7.2	0.92	3.2
	2.5	2.6 (5.9)	75/63	11.7	9.4	14.1	0.76	15.3		60	11.4	8.6	0.79	4.2
			80/67	12.5	9.7	14.9	0.77	16.4		70	11.1	8.3	0.86	3.8
			85/71	13.3	10	15.8	0.76	17.4		80	10.9	7.8	0.93	3.4
	3.5	4.8 (11.0)	75/63	11.8	9.4	14.2	0.75	15.9		60	11.7	9.2	0.79	4.3
			80/67	12.7	9.8	15.1	0.74	17.2		70	11.4	8.6	0.86	3.9
			85/71	13.6	10	15.9	0.74	18.4		80	11.2	8.1	0.94	3.5
80	1.5	1 (2.3)	75/63	10.7	8.9	13.5	0.89	12	60	60	12	9.4	0.79	4.4
			80/67	11.4	9.2	14.2	0.9	12.6		70	11.8	8.9	0.87	4
			85/71	12.1	9.5	15	0.91	13.3		80	11.5	8.4	0.95	3.6
	2.5	2.5 (5.7)	75/63	11.1	9.1	13.7	0.85	13.1		60	12.9	10.3	0.8	4.7
			80/67	11.8	9.4	14.5	0.85	13.9		70	12.5	9.7	0.88	4.2
			85/71	12.6	9.7	15.3	0.85	14.8		80	12.2	9.1	0.96	3.7
	3.5	4.6 (10.6)	75/63	11.2	9.2	13.8	0.83	13.5		60	13.3	10.7	0.81	4.8
			80/67	12	9.4	14.6	0.83	14.5		70	12.9	10.1	0.89	4.3
			85/71	12.8	9.7	15.5	0.83	15.5		80	12.6	9.4	0.97	3.8
85	1.5	1 (2.3)	75/63	10.4	8.8	13.3	0.93	11.2	70	60	13.4	10.8	0.81	4.9
			80/67	11.1	9.1	14	0.94	11.8		70	13.1	10.2	0.89	4.3
			85/71	11.8	9.4	14.8	0.95	12.4		80	12.8	9.7	0.97	3.9
	2.5	2.5 (5.7)	75/63	10.7	9	13.5	0.89	12.1		60	14.4	11.8	0.82	5.2
			80/67	11.5	9.3	14.3	0.89	12.9		70	14	11.1	0.9	4.5
			85/71	12.2	9.6	15.1	0.9	13.6		80	13.7	10.4	0.99	4.1
	3.5	4.5 (10.3)	75/63	10.9	9	13.5	0.87	12.6		60	14.9	12.3	0.82	5.3
			80/67	11.6	9.3	14.4	0.87	13.3		70	14.5	11.5	0.91	4.7
			85/71	12.4	9.6	15.2	0.88	14.2		80	14.1	10.8	1	4.1
90	1.5	1 (2.3)	75/63	10.1	8.7	13.1	0.98	10.4	80	60	14.9	12.2	0.82	5.3
			80/67	10.7	9	13.8	0.99	10.9		70	14.5	11.6	0.91	4.7
			85/71	11.5	9.3	14.6	1	11.6		80	14.2	11	1	4.2
	2.5	2.4 (5.5)	75/63	10.4	8.8	13.3	0.93	11.2		60	16	13.3	0.83	5.6
			80/67	11.1	9.1	14.1	0.94	11.9		70	15.6	12.6	0.93	4.9
			85/71	11.9	9.4	14.8	0.94	12.6		80	15.2	11.9	1.02	4.4
	3.5	4.5 (9.9)	75/63	10.5	8.8	13.4	0.92	11.4		60	16.6	13.9	0.84	5.8
			80/67	11.3	9.2	14.1	0.91	12.4		70	16.1	13.1	0.93	5.1
			85/71	12.1	9.5	14.9	0.92	13.2		80	15.6	12.3	1.03	4.5
100	1.5	0.9 (2.0)	75/63	9.4	8.4	12.6	1.06	8.9	* Extended Range - Anti-freeze required					
			80/67	10.1	8.8	13.4	1.07	9.4		▶ AHRI/ISO13256-1 certified performance is rated at entering air conditions of 80.6°F DB and 66.2°F WB in cooling and 68°F DB in heating.				
			85/71	10.8	9	14.1	1.08	10		▶ Tabulated unit performance does not include fan or pump power corrections required for AHRI/ISO standard performance ratings.				
	2.5	2.4 (5.5)	75/63	9.7	8.5	12.8	1.02	9.5		▶ Unit performance may be interpolated. Extrapolation is not allowed.				
			80/67	10.4	8.8	13.6	1.03	10.1		▶ For conditions other than rating conditions provided, consult the FHP BST selection software.				
			85/71	11.1	9.2	14.3	1.03	10.7		▶ Ratings below 40°F are with a methanol solution.				
	3.5	4.3 (9.9)	75/63	9.8	8.6	12.9	1.01	9.8		▶ The results reported herein are estimates based on testing by FHP. Variations in the installation and operational environment may alter performance. Bosch disclaims all warranties, express and implied, that the performance will be as reported, including the warranty of merchantability and fitness for purpose. In addition, continuous research and development may result in a change to an appliances design and specifications, which Bosch may change without notice. Before purchase, confirm the design specifications of the appliance.				
			80/67	10.5	8.9	13.6	1.01	10.5		▶ Continuous research and development of our products may result in a change				
			85/71	11.3	9.3	14.4	1.01	11.2		Bosch Thermotechnology Corp.				
110	1.5	0.9 (2.0)	75/63	8.8	8.1	12.2	1.15	7.7	Watertown, MA • Londonderry, NH • Ft. Lauderdale, FL					
			80/67	9.4	8.5	12.9	1.16	8.1						
			85/71	10	8.8	13.6	1.17	8.6						
	2.5	2.3 (5.3)	75/63	9	8.3	12.4	1.11	8.1						
			80/67	9.7	8.5	13.1	1.12	8.7						
			85/71	10.4	8.9	13.9	1.13	9.2						
	3.5	4.2 (9.6)	75/63	9.1	8.3	12.5	1.1	8.3						
			80/67	9.8	8.7	13.2	1.1	8.9						
			85/71	10.5	9	13.9	1.11	9.5						



# Greensource i Series Model SV

## Water Source Heat Pump ½ to 6 Ton



### SV015 (500 CFM) Capacity Data

COOLING										HEATING				
Entering Fluid Temp (F)	Water Flow (GPM)	Pressure Drop PSI (FOH)	Entering Air Temp (db/wb) F	Total Capacity (MBTUH)	Sensible Capacity (MBTUH)	Heat of Rejection (MBTUH)	Power Input (kW)	EER	Entering Fluid Temp (F)	Entering Air Temp (F)	Total Capacity (MBTUH)	Heat of Absorption (MBTUH)	Power Input (kW)	COP
50	2	2 (4.62)	75/63	15.2	11.5	17.7	0.77	19.8	30*	60	10.1	7.1	0.93	3.2
			80/67	16.3	11.9	18.7	0.76	21.5		70	9.9	6.7	1	2.9
			85/71	17.3	12.3	19.8	0.75	23.2		80	9.9	6.2	1.08	2.7
	3	4.2 (9.6)	75/63	15.6	11.7	17.9	0.71	21.9		60	10.5	7.5	0.94	3.3
			80/67	16.7	12.1	19	0.7	24		70	10.3	7.1	1.01	3
			85/71	17.9	12.5	20.1	0.68	26.4		80	10.3	6.5	1.09	2.8
	4.5	8.6 (19.8)	75/63	15.9	11.9	18.1	0.67	23.6		60	10.8	7.8	0.94	3.4
			80/67	17.1	12.3	19.2	0.65	26.2		70	10.6	7.3	1.02	3
			85/71	18.3	12.7	20.4	0.63	29		80	10.6	6.7	1.1	2.8
60	2	1.9 (4.3)	75/63	14.5	11.2	17.3	0.86	16.8	40*	60	11.6	8.5	0.96	3.6
			80/67	15.5	11.6	18.3	0.86	18.1		70	11.3	8	1.04	3.2
			85/71	16.6	12	19.3	0.85	19.6		80	11.1	7.5	1.12	2.9
	3	4 (9.2)	75/63	14.9	11.4	17.5	0.81	18.4		60	12	9	0.96	3.6
			80/67	16	11.8	18.6	0.8	20.1		70	11.8	8.4	1.05	3.3
			85/71	17.1	12.2	19.6	0.78	21.9		80	11.6	7.9	1.13	3
	4.5	8.3 (19.1)	75/63	15.2	11.5	17.7	0.77	19.6		60	12.5	9.4	0.97	3.8
			80/67	16.3	11.9	18.7	0.76	21.5		70	12.2	8.8	1.06	3.4
			85/71	17.4	12.3	19.8	0.74	23.6		80	12.1	8	1.14	3.1
70	2	1.9 (4.3)	75/63	13.8	11	16.8	0.96	14.4	50	60	13.2	9.9	0.98	3.9
			80/67	14.8	11.3	17.8	0.96	15.5		70	13.2	9.3	1.07	3.6
			85/71	15.8	11.7	18.8	0.95	16.6		80	12.7	8.7	1.16	3.2
	3	3.9 (8.9)	75/63	14.2	11.1	17	0.91	15.6		60	13.7	10.7	0.99	4
			80/67	15.2	11.5	18.1	0.9	16.9		70	13.4	10	1.08	3.7
			85/71	16.3	11.9	19.1	0.89	18.3		80	13.1	9.3	1.17	3.3
	4.5	8.1 (18.6)	75/63	14.4	11.2	17.2	0.88	16.4		60	14.2	11.1	1	4.2
			80/67	15.5	11.6	18.2	0.86	18		70	13.9	10.3	1.08	3.8
			85/71	16.6	12	19.3	0.85	19.6		80	13.5	9.7	1.17	3.4
80	2	1.8 (4.1)	75/63	13	10.6	16.4	1.06	12.3	60	60	14.8	11.6	1	4.3
			80/67	14	11.1	17.3	1.06	13.2		70	14.5	11	1.09	3.9
			85/71	14.9	11.4	18.3	1.06	14.1		80	14.1	10.3	1.18	3.5
	3	3.8 (8.7)	75/63	13.4	10.7	16.6	1.01	13.2		60	15.8	12.2	1.01	4.6
			80/67	14.4	11.2	17.5	1.01	14.3		70	15.4	11.4	1.1	4.1
			85/71	15.4	11.6	18.6	1	15.4		80	14.8	10.9	1.19	3.6
	4.5	7.8 (17.9)	75/63	13.6	10.9	16.7	0.98	13.8		60	16.4	12.7	1.01	4.7
			80/67	14.6	11.2	17.7	0.97	15		70	16	11.8	1.11	4.2
			85/71	15.7	11.7	18.7	0.96	16.3		80	15.3	11.3	1.2	3.7
85	2	1.8 (4.1)	75/63	12.7	10.4	16.1	1.11	11.4	70	60	16.5	13.4	1.02	4.8
			80/67	13.6	10.9	17	1.11	12.2		70	16.5	12.4	1.11	4.4
			85/71	14.5	11.3	18	1.11	13.1		80	16	11.7	1.21	3.9
	3	3.7 (8.5)	75/63	13	10.6	16.3	1.07	12.2		60	17.7	14	1.02	5.1
			80/67	13.9	11.1	17.3	1.06	13.1		70	17.5	13	1.12	4.6
			85/71	15	11.4	18.3	1.05	14.2		80	17.1	12.1	1.22	4.1
	4.5	7.7 (17.7)	75/63	13.2	10.7	16.4	1.04	12.7		60	18	14.8	1.02	5.2
			80/67	14.2	11.1	17.4	1.03	13.8		70	17.9	13.6	1.13	4.7
			85/71	15.2	11.5	18.5	1.02	14.9		80	17.4	12.7	1.23	4.2
90	2	1.8 (4.1)	75/63	12.3	10.3	15.9	1.16	10.6	80	60	18.4	14.9	1.03	5.3
			80/67	13.2	10.7	16.8	1.16	11.3		70	18.2	14.1	1.13	4.7
			85/71	14.1	11.1	17.8	1.16	12.1		80	18	13	1.23	4.3
	3	3.6 (8.3)	75/63	12.6	10.4	16.1	1.12	11.3		60	19.6	15.9	1.03	5.6
			80/67	13.5	10.9	17	1.12	12.1		70	19.1	15	1.14	4.9
			85/71	14.5	11.3	18	1.11	13.1		80	18.9	13.9	1.24	4.5
	4.5	7.6 (17.5)	75/63	12.8	10.6	16.2	1.09	11.7		60	20.4	16.5	1.03	5.8
			80/67	13.8	10.9	17.2	1.09	12.7		70	19.8	15.6	1.14	5.1
			85/71	14.8	11.4	18.2	1.08	13.8		80	19.5	14.4	1.25	4.6
100	2	1.7 (3.9)	75/63	11.5	9.9	15.4	1.27	9.1	Extended Range - Anti-freeze required					
			80/67	12.3	10.4	16.3	1.27	9.7		▶ AHRI/ISO13256-1 certified performance is rated at entering air conditions of 80.6°F DB and 66.2°F WB in cooling and 68°F DB in heating.				
			85/71	13.2	10.8	17.2	1.27	10.4		▶ Tabulated unit performance does not include fan or pump power corrections required for AHRI/ISO standard performance ratings.				
	3	3.5 (8.0)	75/63	11.8	10	15.6	1.23	9.6		▶ Unit performance may be interpolated. Extrapolation is not allowed.				
			80/67	12.7	10.5	16.5	1.23	10.4		▶ For conditions other than rating conditions provided, consult the FHP BST selection software.				
			85/71	13.6	10.9	17.5	1.23	11.1		▶ Ratings below 40°F are with a methanol solution.				
	4.5	7.3 (16.8)	75/63	12	10.1	15.7	1.21	9.9		▶ The results reported herein are estimates based on testing by FHP. Variations in the installation and operational environment may alter performance. Bosch disclaims all warranties, express and implied, that the performance will be as reported, including the warranty of merchantability and fitness for purpose. In addition, continuous research and development may result in a change to an appliances design and specifications, which Bosch may change without notice. Before purchase, confirm the design specifications of the appliance.				
			80/67	12.9	10.6	16.6	1.2	10.8						
			85/71	13.9	11	17.6	1.2	11.6						
110	2	1.7 (3.9)	75/63	10.7	9.6	15	1.38	7.8						
			80/67	11.5	10	15.8	1.38	8.3						
			85/71	12.4	10.4	16.7	1.39	8.9						
	3	3.4 (7.8)	75/63	11	9.7	15.1	1.34	8.2						
			80/67	11.8	10.2	16	1.34	8.8						
			85/71	12.7	10.6	16.9	1.34	9.5						
	4.5	7.1 (16.3)	75/63	11.1	9.8	15.2	1.32	8.4						
			80/67	12	10.3	16.1	1.32	9.1						
			85/71	12.9	10.7	17	1.31	9.8						

# Greensource i Series Model SV

## Water Source Heat Pump 1/2 to 6 Ton



# BOSCH

### SV018 (650 CFM) Capacity Data

COOLING									HEATING					
Entering Fluid Temp (F)	Water Flow (GPM)	Pressure Drop PSI (FOH)	Entering Air Temp (db/wb) F	Total Capacity (MBTUH)	Sensible Capacity (MBTUH)	Heat of Rejection (MBTUH)	Power Input (kW)	EER	Entering Fluid Temp (F)	Entering Air Temp (F)	Total Capacity (MBTUH)	Heat of Absorption (MBTUH)	Power Input (kW)	COP
50	2.5	1.2 (2.7)	75/63	22.3	15.9	26.1	1.24	18	30*	60	12.3	9	1.11	3.2
			80/67	24.1	16.5	27.9	1.25	19.3		70	11.6	8.3	1.15	3
			85/71	25.9	17	29.8	1.26	20.6		80	10.9	7.5	1.18	2.7
	4	2.9 (6.6)	75/63	23.5	16.3	27.1	1.15	20.4		60	13.1	9.8	1.14	3.4
			80/67	25.4	16.9	29	1.15	22.1		70	12.3	8.9	1.18	3.1
			85/71	27.4	17.4	31	1.15	23.9		80	11.6	8	1.21	2.8
	5	4.3 (9.9)	75/63	23.9	16.5	27.4	1.12	21.3		60	13.4	10.1	1.15	3.4
			80/67	25.8	17.1	29.4	1.12	23.1		70	12.6	9.2	1.19	3.1
			85/71	27.9	17.6	31.4	1.11	25.3		80	11.8	8.2	1.22	2.8
60	2.5	1.2 (2.7)	75/63	21.1	15.3	25.1	1.33	15.9	40*	60	14.7	11.2	1.19	3.6
			80/67	22.8	15.9	26.9	1.34	17		70	14	10.3	1.24	3.3
			85/71	24.5	16.4	28.7	1.36	18.1		80	13.3	9.5	1.28	3
	4	2.8 (6.4)	75/63	22.2	15.8	26	1.25	17.8		60	15.8	12.1	1.22	3.8
			80/67	24	16.4	27.9	1.26	19.1		70	15	11.2	1.27	3.5
			85/71	25.9	16.9	29.8	1.26	20.6		80	14.2	10.2	1.31	3.2
	5	4.1 (9.4)	75/63	22.6	16	26.3	1.22	18.5		60	16.2	12.5	1.23	3.8
			80/67	24.5	16.5	28.2	1.22	20.1		70	15.3	11.5	1.28	3.5
			85/71	26.4	17.1	30.3	1.22	21.7		80	14.5	10.5	1.33	3.2
70	2.5	1.1 (2.54)	75/63	19.8	14.8	24	1.42	14	50	60	17.6	13.4	1.26	4.1
			80/67	21.4	15.3	25.7	1.44	14.9		70	16.8	12.4	1.32	3.7
			85/71	23.1	15.7	27.6	1.46	15.9		80	15.8	11.6	1.38	3.4
	4	2.7 (6.2)	75/63	20.8	15.2	24.9	1.35	15.5		60	18.9	14.5	1.3	4.3
			80/67	22.6	15.8	26.7	1.36	16.7		70	18	13.4	1.36	3.9
			85/71	24.5	16.2	28.7	1.37	17.9		80	17.1	12.3	1.42	3.5
	5	4 (9.2)	75/63	21.2	15.4	25.2	1.32	16.1		60	19.1	15.2	1.31	4.3
			80/67	23	16	27	1.33	17.3		70	18.5	13.8	1.37	3.9
			85/71	24.9	16.4	29.1	1.33	18.7		80	17.5	12.6	1.43	3.6
80	2.5	1.1 (2.54)	75/63	18.5	14.1	22.9	1.5	12.4	60	60	20.3	15.9	1.33	4.5
			80/67	20.1	14.6	24.6	1.53	13.2		70	19.5	14.8	1.4	4.1
			85/71	21.6	15.3	26.2	1.55	13.9		80	18.4	13.9	1.47	3.7
	4	2.6 (5.9)	75/63	19.5	14.5	23.7	1.44	13.6		60	21.6	17.5	1.37	4.6
			80/67	21.1	15.1	25.5	1.46	14.5		70	20.9	16	1.45	4.2
			85/71	22.9	15.6	27.4	1.47	15.6		80	19.9	14.7	1.52	3.8
	5	3.9 (8.9)	75/63	19.8	14.7	24	1.42	14		60	22.1	18.1	1.39	4.7
			80/67	21.5	15.3	25.8	1.43	15		70	21.5	16.4	1.46	4.3
			85/71	23.4	15.8	27.7	1.44	16.2		80	20.4	15.1	1.53	3.9
85	2.5	1.1 (2.54)	75/63	17.8	13.8	22.3	1.54	11.6	70	60	23.2	18.4	1.4	4.8
			80/67	19.3	14.5	23.9	1.57	12.3		70	22	17.5	1.49	4.3
			85/71	20.8	15	25.6	1.6	13		80	21.1	16.3	1.56	3.9
	4	2.6 (5.9)	75/63	18.8	14.2	23.1	1.49	12.7		60	25	20	1.44	5.1
			80/67	20.3	14.9	24.8	1.51	13.5		70	23.9	18.6	1.53	4.6
			85/71	22	15.5	26.6	1.53	14.4		80	22.8	17.2	1.61	4.1
	5	3.8 (8.7)	75/63	19.1	14.3	23.4	1.47	13		60	25.3	21	1.46	5.1
			80/67	20.8	14.9	25.2	1.49	14		70	24.5	19.1	1.54	4.6
			85/71	22.5	15.5	27	1.5	15		80	23.4	17.7	1.63	4.2
90	2.5	1.1 (2.54)	75/63	17.1	13.6	21.7	1.58	10.8	80	60	26	21.1	1.46	5.2
			80/67	18.6	14.2	23.3	1.62	11.5		70	24.8	20	1.56	4.7
			85/71	20.1	14.7	25	1.65	12.2		80	23.8	18.7	1.65	4.2
	4	2.5 (5.7)	75/63	18	13.8	22.5	1.53	11.8		60	28.1	22.9	1.5	5.5
			80/67	19.6	14.6	24.1	1.56	12.6		70	26.9	21.4	1.6	4.9
			85/71	21.2	15.1	25.9	1.58	13.5		80	25.5	20.1	1.7	4.4
	5	3.8 (8.7)	75/63	18.3	14	22.7	1.51	12.1		60	28.5	24	1.52	5.5
			80/67	19.9	14.6	24.5	1.53	13		70	27.6	21.9	1.62	5
			85/71	21.6	15.3	26.3	1.55	13.9		80	25.9	20.7	1.71	4.4
100	2.5	1 (2.3)	75/63	15.6	13	20.3	1.65	9.5	Extended Range - Anti-freeze required					
			80/67	17	13.6	21.9	1.7	10		▶ AHRI/ISO13256-1 certified performance is rated at entering air conditions of 80.6°F DB and 66.2°F WB in cooling and 68°F DB in heating.				
			85/71	18.5	14.1	23.6	1.74	10.7		▶ Tabulated unit performance does not include fan or pump power corrections required for AHRI/ISO standard performance ratings.				
	4	2.4 (5.5)	75/63	16.5	13.3	21.1	1.61	10.2		▶ Unit performance may be interpolated. Extrapolation is not allowed.				
			80/67	18	14	22.8	1.65	10.9		▶ For conditions other than rating conditions provided, consult the FHP BST selection software.				
			85/71	19.6	14.5	24.5	1.68	11.7		▶ Ratings below 40°F are with a methanol solution.				
	5	3.6 (8.3)	75/63	16.8	13.5	21.4	1.6	10.5		▶ The results reported herein are estimates based on testing by FHP. Variations in the installation and operational environment may alter performance. Bosch disclaims all warranties, express and implied, that the performance will be as reported, including the warranty of merchantability and fitness for purpose. In addition, continuous research and development may result in a change to an appliances design and specifications, which Bosch may change without notice. Before purchase, confirm the design specifications of the appliance.				
			80/67	18.3	14.1	23.1	1.63	11.3		▶ Continuous research and development by Bosch Thermotechnology Corp. change				
			85/71	20	14.6	24.9	1.66	12.1		Watertown, MA • Londonderry, NH • Ft. Lauderdale, FL				
110	2.5	1 (2.3)	75/63	14.1	12.3	18.9	1.72	8.2						
			80/67	15.4	12.9	20.4	1.77	8.7						
			85/71	16.7	13.7	21.9	1.81	9.2						
	4	2.4 (5.5)	75/63	14.9	12.6	19.6	1.69	8.8						
			80/67	16.4	13.2	21.3	1.73	9.5						
			85/71	17.8	13.9	23	1.77	10.1						
	5	3.5 (8.0)	75/63	15.1	12.8	19.8	1.68	9						
			80/67	16.7	13.3	21.6	1.72	9.7						
			85/71	18.2	14	23.3	1.75	10.4						

# Greensource i Series Model SV

## Water Source Heat Pump ½ to 6 Ton



# BOSCH

### SV024 (850 CFM) Capacity Data

COOLING										HEATING				
Entering Fluid Temp (F)	Water Flow (GPM)	Pressure Drop PSI (FOH)	Entering Air Temp (db/wb) F	Total Capacity (MBTUH)	Sensible Capacity (MBTUH)	Heat of Rejection (MBTUH)	Power Input (kW)	EER	Entering Fluid Temp (F)	Entering Air Temp (F)	Total Capacity (MBTUH)	Heat of Absorption (MBTUH)	Power Input (kW)	COP
50	3	1.8 (4.1)	75/63	25.6	18.6	30	1.44	17.8	30*	60	15.3	11.2	1.37	3.3
			80/67	27.5	19.2	32	1.45	19		70	14.6	10.3	1.43	3
			85/71	29.5	19.8	34	1.45	20.4		80	13.9	9.3	1.48	2.7
	5	4.5 (10.3)	75/63	26.9	19.1	31	1.33	20.2		60	16.3	12	1.42	3.4
			80/67	28.9	19.8	33.1	1.33	21.8		70	15.5	11.1	1.47	3.1
			85/71	31.1	20.4	35.3	1.31	23.7		80	14.7	10	1.52	2.8
	7	8.2 (18.9)	75/63	27.5	19.4	31.5	1.28	21.5		60	16.8	12.5	1.44	3.4
			80/67	29.6	20.1	33.6	1.27	23.4		70	15.9	11.5	1.5	3.1
			85/71	31.8	20.7	35.8	1.25	25.5		80	15.1	10.4	1.55	2.9
60	3	1.7 (3.9)	75/63	24.3	18	29	1.55	15.7	40*	60	18	13.4	1.48	3.6
			80/67	26.1	18.6	30.9	1.56	16.7		70	17.2	12.5	1.55	3.3
			85/71	28	19.2	32.9	1.58	17.8		80	16.4	11.5	1.61	3
	5	4.3 (9.9)	75/63	25.5	18.5	29.9	1.45	17.6		60	19.3	14.6	1.53	3.7
			80/67	27.5	19.2	32	1.45	19		70	18.4	13.5	1.6	3.4
			85/71	29.6	19.8	34.1	1.45	20.5		80	17.5	12.5	1.66	3.1
	7	7.9 (18.2)	75/63	26.1	18.8	30.4	1.4	18.6		60	20	15.2	1.55	3.8
			80/67	28.1	19.4	32.5	1.4	20.1		70	19	14	1.62	3.4
			85/71	30.3	20.1	34.6	1.38	21.9		80	18.1	12.9	1.68	3.2
70	3	1.7 (3.9)	75/63	22.9	17.3	27.9	1.66	13.8	50	60	20.9	16	1.58	3.9
			80/67	24.7	18	29.8	1.68	14.7		70	20.1	14.9	1.66	3.5
			85/71	26.5	18.6	31.7	1.7	15.6		80	19.6	13.7	1.73	3.3
	5	4.2 (9.6)	75/63	24.1	17.8	28.8	1.57	15.4		60	22.4	17.5	1.63	4
			80/67	26	18.5	30.8	1.58	16.5		70	21.5	16.2	1.71	3.7
			85/71	27.9	19.2	32.8	1.58	17.6		80	21	14.8	1.79	3.4
	7	7.7 (17.7)	75/63	24.6	18.1	29.2	1.53	16.1		60	23.3	18.1	1.66	4.1
			80/67	26.6	18.8	31.3	1.53	17.4		70	22.2	16.8	1.74	3.7
			85/71	28.6	19.4	33.4	1.53	18.8		80	21.6	15.2	1.82	3.5
80	3	1.6 (3.6)	75/63	21.5	16.6	26.7	1.77	12.1	60	60	24	18.7	1.68	4.2
			80/67	23.1	17.3	28.5	1.8	12.8		70	23.1	17.6	1.77	3.8
			85/71	24.9	17.9	30.4	1.83	13.6		80	22.6	16.2	1.86	3.6
	5	4 (9.2)	75/63	22.5	17.2	27.6	1.69	13.3		60	25.8	20.4	1.73	4.4
			80/67	24.4	17.8	29.5	1.71	14.3		70	24.8	19.2	1.83	4
			85/71	26.3	18.5	31.5	1.72	15.3		80	24.2	17.4	1.92	3.7
	7	7.4 (16.8)	75/63	23	17.4	28	1.65	13.9		60	26.8	21.3	1.75	4.5
			80/67	24.9	18	30	1.66	15		70	25.7	19.9	1.86	4.1
			85/71	26.9	18.7	32	1.67	16.1		80	24.5	18.4	1.95	3.7
85	3	1.6 (3.6)	75/63	20.7	16.3	26.1	1.83	11.3	70	60	27.1	21.6	1.76	4.5
			80/67	22.4	17	27.9	1.86	12.1		70	26.2	20.4	1.87	4.1
			85/71	24.1	17.6	29.7	1.89	12.8		80	25.2	19.1	1.98	3.7
	5	4 (9.2)	75/63	21.8	16.8	26.9	1.75	12.5		60	29.3	23.6	1.82	4.7
			80/67	23.5	17.5	28.9	1.77	13.3		70	28.2	22.1	1.93	4.3
			85/71	25.4	18.1	30.8	1.79	14.2		80	27	20.6	2.04	3.9
	7	7.3 (16.8)	75/63	22.2	17	27.3	1.71	13		60	30.4	24.6	1.84	4.8
			80/67	24.1	17.7	29.3	1.73	13.9		70	29.2	23	1.96	4.4
			85/71	26	18.3	31.3	1.74	14.9		80	27.9	21.3	2.07	3.9
90	3	1.6 (3.6)	75/63	20	15.9	25.5	1.88	10.7	80	60	30.4	24.6	1.84	4.8
			80/67	21.5	16.7	27.2	1.92	11.2		70	29.4	23.2	1.97	4.4
			85/71	23.2	17.2	29.1	1.95	11.9		80	28.3	21.8	2.09	4
	5	3.9 (8.9)	75/63	21	16.4	26.3	1.81	11.6		60	32.8	26.9	1.89	5.1
			80/67	22.7	17.1	28.2	1.84	12.4		70	31.6	25.2	2.02	4.6
			85/71	24.5	17.7	30.1	1.86	13.2		80	30.3	23.5	2.15	4.1
	7	7.2 (16.6)	75/63	21.4	16.6	26.7	1.78	12.1		60	34	28	1.91	5.2
			80/67	23.2	17.3	28.6	1.8	12.9		70	32.7	26.2	2.05	4.7
			85/71	25.1	17.9	30.6	1.81	13.9		80	31.3	24.3	2.18	4.2
100	3	1.5 (3.4)	75/63	18.4	15.2	24.1	1.98	9.3	Extended Range - Anti-freeze required					
			80/67	19.9	15.9	25.8	2.03	9.8		▶ AHRI/ISO13256-1 certified performance is rated at entering air conditions of 80.6°F DB and 66.2°F WB in cooling and 68°F DB in heating.				
			85/71	21.4	16.6	27.6	2.07	10.3		▶ Tabulated unit performance does not include fan or pump power corrections required for AHRI/ISO standard performance ratings.				
	5	3.8 (8.7)	75/63	19.3	15.7	24.9	1.92	10.1		▶ Unit performance may be interpolated. Extrapolation is not allowed.				
			80/67	20.9	16.4	26.7	1.96	10.7		▶ For conditions other than rating conditions provided, consult the FHP BST selection software.				
			85/71	22.6	17.1	28.6	1.99	11.4		▶ Ratings below 40°F are with a methanol solution.				
	7	7 (16.1)	75/63	19.7	15.9	25.2	1.89	10.4		▶ The results reported herein are estimates based on testing by FHP. Variations in the installation and operational environment may alter performance. Bosch disclaims all warranties, express and implied, that the performance will be as reported, including the warranty of merchantability and fitness for purpose. In addition, continuous research and development may result in a change to an appliances design and specifications, which Bosch may change without notice. Before purchase, confirm the design specifications of the appliance.				
			80/67	21.4	16.6	27.1	1.93	11.1		▶ Continuous research and development by Bosch Thermotechnology Corp. change				
			85/71	23.2	17.3	29	1.95	11.9		Watertown, MA • Londonderry, NH • Ft. Lauderdale, FL				
110	3	1.5 (3.4)	75/63	16.7	14.6	22.6	2.08	8.1						
			80/67	18.1	15.3	24.3	2.13	8.5						
			85/71	19.5	15.9	26	2.19	8.9						
	5	3.7 (8.5)	75/63	17.5	15	23.4	2.03	8.6						
			80/67	19.1	15.6	25.2	2.08	9.2						
			85/71	20.7	16.3	27	2.12	9.8						
	7	6.8 (15.6)	75/63	17.9	15.1	23.7	2.01	8.9						
			80/67	19.6	15.8	25.6	2.05	9.6						
			85/71	21.2	16.6	27.4	2.09	10.2						

# Greensource i Series Model SV

## Water Source Heat Pump ½ to 6 Ton



### SV030 (950 CFM) Capacity Data

COOLING										HEATING				
Entering Fluid Temp (F)	Water Flow (GPM)	Pressure Drop PSI (FOH)	Entering Air Temp (db/wb) F	Total Capacity (MBTUH)	Sensible Capacity (MBTUH)	Heat of Rejection (MBTUH)	Power Input (kW)	EER	Entering Fluid Temp (F)	Entering Air Temp (F)	Total Capacity (MBTUH)	Heat of Absorption (MBTUH)	Power Input (kW)	COP
50	3.5	1.7 (3.9)	75/63	34.3	25.3	39.4	1.65	20.8	30*	60	18.3	13.9	1.46	3.7
			80/67	36.8	26.1	42	1.66	22.2		70	17.5	12.8	1.53	3.4
			85/71	39.4	26.9	44.6	1.66	23.8		80	16.6	11.6	1.59	3.1
	6	4.5 (10.3)	75/63	36.1	26.1	40.8	1.5	24.1		60	19.8	15.3	1.51	3.8
			80/67	38.8	27	43.5	1.48	26.2		70	18.8	14	1.58	3.5
			85/71	41.7	27.8	46.4	1.46	28.6		80	17.8	12.6	1.64	3.2
	9	9.3 (21.4)	75/63	37	26.5	41.5	1.42	26		60	20.7	16	1.54	3.9
			80/67	39.8	27.4	44.3	1.4	28.5		70	19.6	14.7	1.62	3.6
			85/71	42.8	28.2	47.2	1.36	31.5		80	18.4	13.3	1.68	3.2
60	3.5	1.6 (3.7)	75/63	32.5	24.5	38	1.8	18.1	40*	60	21.7	16.9	1.58	4
			80/67	34.9	25.4	40.5	1.81	19.3		70	20.8	15.7	1.66	3.7
			85/71	37.3	26.1	43	1.82	20.5		80	19.8	14.5	1.74	3.3
	6	4.3 (9.9)	75/63	34.2	25.3	39.3	1.66	20.6		60	23.6	18.6	1.64	4.2
			80/67	36.9	26.2	42	1.65	22.3		70	22.5	17.2	1.73	3.8
			85/71	39.6	27	44.8	1.64	24.2		80	21.3	15.8	1.81	3.5
	9	8.9 (20.5)	75/63	35.1	25.6	40	1.59	22.1		60	24.7	19.5	1.68	4.3
			80/67	37.8	26.6	42.8	1.57	24.1		70	23.5	18	1.77	3.9
			85/71	40.7	27.4	45.6	1.54	26.3		80	22.2	16.5	1.85	3.5
70	3.5	1.6 (3.7)	75/63	30.6	23.7	36.5	1.94	15.7	50	60	25.4	20.1	1.7	4.4
			80/67	33	24.4	39	1.97	16.8		70	24.5	18.7	1.8	4
			85/71	35.3	25.4	41.4	1.99	17.8		80	23.3	17.4	1.89	3.6
	6	4.2 (9.6)	75/63	32.2	24.4	37.8	1.82	17.7		60	27.7	22.3	1.76	4.6
			80/67	34.8	25.3	40.4	1.82	19.1		70	26.6	20.7	1.87	4.2
			85/71	37.4	26.1	43.1	1.82	20.5		80	25.4	19.1	1.97	3.8
	9	8.6 (19.8)	75/63	33	24.7	38.4	1.75	18.8		60	29.1	23.5	1.8	4.7
			80/67	35.7	25.7	41.1	1.75	20.4		70	27.8	21.8	1.9	4.3
			85/71	38.4	26.5	43.9	1.73	22.1		80	26.5	20.1	2	3.9
80	3.5	1.5 (3.4)	75/63	28.7	22.7	35	2.09	13.7	60	60	29.7	23.5	1.8	4.8
			80/67	30.9	23.6	37.4	2.12	14.5		70	28.2	22.3	1.92	4.3
			85/71	33.2	24.4	39.8	2.15	15.4		80	27.2	20.8	2.03	3.9
	6	4 (9.2)	75/63	30.2	23.3	36.2	1.98	15.3		60	32.1	26.3	1.87	5
			80/67	32.6	24.3	38.8	1.99	16.3		70	30.8	24.6	1.99	4.5
			85/71	35.1	25.1	41.3	2	17.5		80	29.6	22.8	2.11	4.1
	9	8.4 (19.3)	75/63	30.9	23.6	36.8	1.92	16		60	33.6	27.7	1.9	5.2
			80/67	33.4	24.8	39.3	1.93	17.3		70	32.3	25.9	2.03	4.7
			85/71	36	25.7	42	1.93	18.7		80	30.8	24	2.15	4.2
85	3.5	1.5 (3.4)	75/63	27.7	22.4	34.1	2.15	12.8	70	60	33.7	27.3	1.9	5.2
			80/67	29.8	23.3	36.4	2.2	13.6		70	32.2	25.9	2.03	4.7
			85/71	32	24.1	38.8	2.23	14.3		80	31	24.2	2.16	4.2
	6	4 (9.2)	75/63	29.2	22.9	35.4	2.05	14.2		60	36.5	30.4	1.96	5.5
			80/67	31.5	23.9	37.8	2.08	15.2		70	35.1	28.6	2.11	4.9
			85/71	33.9	24.8	40.4	2.09	16.2		80	33.7	26.7	2.24	4.4
	9	8.2 (18.9)	75/63	29.8	23.4	35.9	2	14.9		60	38.3	32.1	1.99	5.6
			80/67	32.3	24.3	38.4	2.02	16		70	36.8	30.1	2.14	5
			85/71	34.8	25.1	41.1	2.02	17.2		80	35.2	28	2.29	4.5
90	3.5	1.5 (3.4)	75/63	26.7	21.9	33.3	2.22	12	80	60	37.8	31.1	1.98	5.6
			80/67	28.7	22.8	35.6	2.27	12.6		70	36.2	29.6	2.13	5
			85/71	30.9	23.5	38	2.31	13.3		80	35	27.7	2.28	4.5
	6	3.9 (8.9)	75/63	28	22.5	34.4	2.13	13.1		60	41	34.7	2.03	5.9
			80/67	30.3	23.4	36.9	2.16	14		70	39.5	32.6	2.2	5.3
			85/71	32.7	24.2	39.4	2.18	15		80	38	30.5	2.36	4.7
	9	8.1 (18.6)	75/63	28.7	22.9	34.9	2.08	13.8		60	43.1	36.7	2.06	6.1
			80/67	31.1	23.8	37.5	2.11	14.8		70	41.4	34.3	2.23	5.4
			85/71	33.6	24.6	40.1	2.12	15.8		80	39.7	32	2.4	4.8
100	3.5	1.4 (3.2)	75/63	24.6	21	31.6	2.36	10.4	Extended Range - Anti-freeze required					
			80/67	26.6	21.8	33.8	2.42	11		▶ AHRI/ISO13256-1 certified performance is rated at entering air conditions of 80.6°F DB and 66.2°F WB in cooling and 68°F DB in heating.				
			85/71	28.5	22.8	36	2.47	11.5		▶ Tabulated unit performance does not include fan or pump power corrections required for AHRI/ISO standard performance ratings.				
	6	3.8 (8.7)	75/63	25.9	21.4	32.6	2.28	11.3		▶ Unit performance may be interpolated. Extrapolation is not allowed.				
			80/67	28	22.5	34.9	2.32	12.1		▶ For conditions other than rating conditions provided, consult the FHP BST selection software.				
			85/71	30.2	23.4	37.4	2.36	12.8		▶ Ratings below 40°F are with a methanol solution.				
	9	7.9 (18.2)	75/63	26.4	21.7	33.1	2.24	11.8		▶ The results reported herein are estimates based on testing by FHP. Variations in the installation and operational environment may alter performance. Bosch disclaims all warranties, express and implied, that the performance will be as reported, including the warranty of merchantability and fitness for purpose. In addition, continuous research and development may result in a change to an appliances design and specifications, which Bosch may change without notice. Before purchase, confirm the design specifications of the appliance.				
			80/67	28.6	22.8	35.5	2.28	12.6						
			85/71	31	23.8	38	2.3	13.4						
110	3.5	1.4 (3.2)	75/63	22.6	19.9	29.9	2.48	9.1						
			80/67	24.3	21	31.9	2.55	9.5						
			85/71	26.1	21.9	34	2.62	10						
	6	3.7 (8.5)	75/63	23.6	20.4	30.8	2.42	9.7						
			80/67	25.6	21.4	33	2.48	10.3						
			85/71	27.6	22.5	35.2	2.53	10.9						
	9	7.6 (17.5)	75/63	24	20.6	31.1	2.39	10						
			80/67	26.1	21.7	33.4	2.44	10.7						
			85/71	28.3	22.5	35.8	2.49	11.4						

# Greensource i Series Model SV

## Water Source Heat Pump 1/2 to 6 Ton



SV036 (1200 CFM) Capacity Data														
COOLING									HEATING					
Entering Fluid Temp (F)	Water Flow (GPM)	Pressure Drop PSI (FOH)	Entering Air Temp (db/wb) F	Total Capacity (MBTUH)	Sensible Capacity (MBTUH)	Heat of Rejection (MBTUH)	Power Input (kW)	EER	Entering Fluid Temp (F)	Entering Air Temp (F)	Total Capacity (MBTUH)	Heat of Absorption (MBTUH)	Power Input (kW)	COP
50	4	1.3 (2.9)	75/63	40.8	30	47.7	2.16	18.9	30*	60	23.5	17	2	3.5
			80/67	43.7	31	50.7	2.17	20.1		70	22.4	15.7	2.09	3.2
			85/71	46.7	31.9	53.7	2.18	21.4		80	20.9	13.5	2.15	2.9
	7.5	4.2 (9.6)	75/63	43.4	31	49.7	1.96	22.1		60	25.2	18.7	2.07	3.6
			80/67	46.7	32	53	1.95	24		70	24	17.3	2.17	3.2
			85/71	50	32.9	56.3	1.93	25.9		80	22.7	15.7	2.25	3
	11	8.3 (19.1)	75/63	44.4	31.5	50.4	1.88	23.6		60	26.5	19.6	2.11	3.7
			80/67	47.8	32.4	53.8	1.86	25.7		70	25	18.1	2.21	3.3
			85/71	51.3	33.5	57.2	1.83	28		80	23.7	16.5	2.3	3
60	4	1.3 (2.9)	75/63	38.7	29.1	46	2.33	16.6	40*	60	27.2	20.5	2.15	3.7
			80/67	41.5	30	49	2.35	17.6		70	26.3	18.9	2.26	3.4
			85/71	44.5	30.8	52	2.37	18.8		80	25.5	16.8	2.35	3.2
	7.5	4 (9.6)	75/63	41.2	30.1	47.9	2.14	19.3		60	29.9	22.7	2.24	3.9
			80/67	44.3	31.1	51.1	2.13	20.8		70	28.6	21	2.35	3.6
			85/71	47.6	32	54.4	2.12	22.4		80	27.2	19.2	2.45	3.3
	11	8 (18.4)	75/63	42.1	30.5	48.7	2.06	20.4		60	31	23.7	2.27	4
			80/67	45.4	31.5	51.9	2.05	22.2		70	29.6	22	2.39	3.6
			85/71	48.8	32.4	55.3	2.02	24.1		80	28.3	20.3	2.5	3.3
70	4	1.3 (2.9)	75/63	36.5	28	44.4	2.51	14.5	50	60	31.9	24.2	2.29	4.1
			80/67	39.3	28.9	47.2	2.54	15.5		70	30.8	22.6	2.42	3.7
			85/71	42	29.8	50.1	2.56	16.4		80	29.3	21.1	2.54	3.4
	7.5	3.9 (8.9)	75/63	38.9	29	46.2	2.33	16.7		60	35	27.2	2.39	4.3
			80/67	41.9	30	49.3	2.33	18		70	33.9	25.2	2.52	3.9
			85/71	45	31.1	52.4	2.32	19.3		80	32.2	22.8	2.64	3.6
	11	7.8 (17.9)	75/63	39.8	29.4	46.9	2.25	17.7		60	36.9	28.3	2.42	4.5
			80/67	42.9	30.4	50	2.25	19.1		70	35.6	25.8	2.56	4.1
			85/71	46.2	31.3	53.3	2.23	20.7		80	33.1	24.8	2.69	3.6
80	4	1.2 (2.7)	75/63	34.3	27	42.6	2.69	12.8	60	60	36.6	28.3	2.42	4.4
			80/67	36.9	28	45.4	2.73	13.5		70	35.4	26.6	2.57	4
			85/71	39.4	29.1	48.1	2.76	14.3		80	33.8	24.9	2.71	3.7
	7.5	3.8 (8.7)	75/63	36.5	27.9	44.3	2.52	14.5		60	40.2	32	2.52	4.7
			80/67	39.3	29	47.3	2.53	15.5		70	37.4	29	2.66	4.1
			85/71	42.3	30.1	50.3	2.54	16.7		80	36.9	27.9	2.83	3.8
	11	7.5 (17.2)	75/63	37.3	28.3	45	2.45	15.2		60	41.9	33.9	2.56	4.8
			80/67	40.3	29.5	48	2.46	16.4		70	40.7	31.1	2.72	4.4
			85/71	43.4	30.3	51.2	2.45	17.7		80	38.3	29.3	2.88	3.9
85	4	1.2 (2.7)	75/63	33.1	26.5	41.7	2.77	11.9	70	60	41.4	32.7	2.54	4.8
			80/67	35.6	27.5	44.4	2.82	12.6		70	39.9	30.9	2.71	4.3
			85/71	38.2	28.4	47.1	2.86	13.4		80	38.7	29	2.88	3.9
	7.5	3.7 (8.5)	75/63	35.2	27.5	43.3	2.61	13.5		60	46	36.9	2.64	5.1
			80/67	38	28.4	46.3	2.64	14.4		70	44.4	34.6	2.82	4.6
			85/71	41	29.4	49.3	2.65	15.5		80	42.9	32	3	4.2
	11	7.4 (17.0)	75/63	36	27.7	44	2.55	14.1		60	48.1	38.7	2.67	5.3
			80/67	39	28.8	47	2.56	15.2		70	46.7	35.7	2.86	4.8
			85/71	42	30	50	2.56	16.4		80	44.7	33.2	3.04	4.3
90	4	1.2 (2.7)	75/63	31.9	26.1	40.6	2.86	11.1	80	60	46.3	37.3	2.64	5.1
			80/67	34.3	27.2	43.3	2.91	11.8		70	44.6	35.2	2.83	4.6
			85/71	36.8	28.2	46	2.95	12.5		80	43.3	33.1	3.02	4.2
	7.5	3.6 (8.3)	75/63	34	26.9	42.3	2.71	12.5		60	51.5	42.1	2.73	5.5
			80/67	36.6	28.1	45.2	2.74	13.4		70	49.2	39.5	2.94	4.9
			85/71	39.5	28.9	48.2	2.76	14.3		80	47.2	37	3.13	4.4
	11	7.3 (16.8)	75/63	34.7	27.2	42.9	2.65	13.1		60	53.8	44.2	2.76	5.7
			80/67	37.5	28.4	45.9	2.67	14		70	52.3	40.8	2.97	5.2
			85/71	40.5	29.5	48.9	2.68	15.1		80	49.3	39	3.18	4.5
100	4	1.1 (2.5)	75/63	29.5	25	38.7	3.03	9.7	80	* Extended Range - Anti-freeze required				
			80/67	31.7	26.3	41.2	3.09	10.2		▶ AHRI/ISO13256-1 certified performance is rated at entering air conditions of 80.6°F DB and 66.2°F WB in cooling and 68°F DB in heating.				
			85/71	34.1	27.2	43.9	3.15	10.8		▶ Tabulated unit performance does not include fan or pump power corrections required for AHRI/ISO standard performance ratings.				
	7.5	3.5 (8.0)	75/63	31.3	26	40.2	2.9	10.8		▶ Unit performance may be interpolated. Extrapolation is not allowed.				
			80/67	34	26.9	43.1	2.94	11.5		▶ For conditions other than rating conditions provided, consult the FHP BST selection software.				
			85/71	36.6	27.9	45.9	2.97	12.3		▶ Ratings below 40°F are with a methanol solution.				
	11	7.1 (16.3)	75/63	32.1	26.1	40.8	2.85	11.2		▶ The results reported herein are estimates based on testing by FHP. Variations in the installation and operational environment may alter performance. Bosch disclaims all warranties, express and implied, that the performance will be as reported, including the warranty of merchantability and fitness for purpose. In addition, continuous research and development may result in a change to an appliances design and specifications, which Bosch may change without notice. Before purchase, confirm the design specifications of the appliance.				
			80/67	34.8	27.2	43.7	2.88	12.1		▶ Continuous research and development by Bosch Thermotechnology Corp. change				
			85/71	37.6	28.2	46.6	2.9	12.9		Watertown, MA • Londonderry, NH • Ft. Lauderdale, FL				
110	4	1.1 (2.5)	75/63	27	24.1	36.7	3.18	8.5						
			80/67	29.1	25.2	39.1	3.26	8.9						
			85/71	31.4	26	41.7	3.34	9.4						
	7.5	3.4 (7.8)	75/63	28.7	24.7	38.1	3.08	9.3						
			80/67	31.1	25.8	40.8	3.14	9.9						
			85/71	33.6	27.1	43.4	3.18	10.5						
	11	6.9 (15.9)	75/63	29.3	24.9	38.6	3.04	9.6						
			80/67	31.8	26.1	41.3	3.09	10.3						
			85/71	34.4	27.3	44.1	3.12	11						

# Greensource i Series Model SV

## Water Source Heat Pump 1/2 to 6 Ton



### SV041 (1150 CFM) Capacity Data

COOLING										HEATING				
Entering Fluid Temp (F)	Water Flow (GPM)	Pressure Drop PSI (FOH)	Entering Air Temp (db/wb) F	Total Capacity (MBTUH)	Sensible Capacity (MBTUH)	Heat of Rejection (MBTUH)	Power Input (kW)	EER	Entering Fluid Temp (F)	Entering Air (F)	Total Capacity (MBTUH)	Heat of Absorption (MBTUH)	Power Input (kW)	COP
50	5	2.1 (4.8)	75/63	44.8	32	52.9	2.52	17.8	30*	60	27.1	19.3	2.44	3.3
			80/67	48.1	33	56.3	2.53	19		70	25.9	17.6	2.54	3
			85/71	51.4	33.9	59.7	2.54	20.2		80	24.6	16	2.62	2.8
	9	6.1 (14.0)	75/63	47.2	33	54.8	2.33	20.3		60	29	20.9	2.52	3.4
			80/67	50.7	34.1	58.3	2.32	21.9		70	27.6	19.2	2.62	3.1
			85/71	54.5	35	62	2.3	23.7		80	26.1	17.4	2.71	2.8
	13	11.9 (27.4)	75/63	48.2	33.5	55.5	2.25	21.4		60	29.9	21.7	2.55	3.4
			80/67	51.8	34.5	59.2	2.23	23.2		70	28.4	19.8	2.66	3.1
			85/71	55.7	35.5	63	2.2	25.3		80	26.8	18	2.75	2.9
60	5	2.1 (4.8)	75/63	42.5	31	51.2	2.71	15.7	40*	60	31.4	23	2.61	3.5
			80/67	45.6	32	54.4	2.73	16.7		70	30.1	21.3	2.74	3.2
			85/71	48.9	32.9	57.8	2.75	17.8		80	28.8	19.6	2.85	3
	9	5.9 (13.6)	75/63	44.8	32	52.9	2.52	17.7		60	33.8	25.1	2.7	3.7
			80/67	48.2	33	56.4	2.52	19.1		70	32.4	23.2	2.83	3.4
			85/71	51.8	34	60	2.51	20.6		80	30.8	21.3	2.95	3.1
	13	11.5 (26.5)	75/63	45.7	32.4	53.6	2.45	18.7		60	35	26.1	2.74	3.7
			80/67	49.3	33.5	57.2	2.44	20.2		70	33.5	24.1	2.87	3.4
			85/71	53	34.5	60.9	2.41	22		80	31.7	21.9	3	3.1
70	5	2 (4.6)	75/63	40.1	29.9	49.3	2.91	13.8	50	60	36.2	27.1	2.78	3.8
			80/67	43.1	31	52.5	2.94	14.6		70	34.9	25.4	2.92	3.5
			85/71	46.2	31.9	55.7	2.97	15.6		80	33.7	23.4	3.07	3.2
	9	5.7 (13.1)	75/63	42.3	30.8	51	2.73	15.5		60	39.2	29.8	2.87	4
			80/67	45.6	31.9	54.4	2.74	16.6		70	37.6	27.9	3.02	3.6
			85/71	49	32.9	57.8	2.74	17.9		80	36.2	25.7	3.17	3.4
	13	11.1 (25.6)	75/63	43.2	31.2	51.7	2.66	16.2		60	40.5	31.1	2.91	4.1
			80/67	46.6	32.3	55.1	2.66	17.5		70	38.8	29	3.07	3.7
			85/71	50.1	33.4	58.7	2.65	18.9		80	37.3	26.7	3.21	3.4
80	5	1.9 (4.3)	75/63	37.6	28.8	47.4	3.11	12.1	60	60	41.2	31.7	2.93	4.1
			80/67	40.5	29.9	50.5	3.15	12.8		70	39.9	29.8	3.1	3.8
			85/71	43.5	30.8	53.6	3.19	13.6		80	38.5	27.8	3.26	3.5
	9	5.6 (12.9)	75/63	39.7	29.7	49	2.95	13.5		60	44.8	34.9	3.03	4.3
			80/67	42.8	30.8	52.3	2.97	14.4		70	43.1	32.6	3.21	3.9
			85/71	46.1	31.8	55.7	2.98	15.5		80	42	29.9	3.38	3.6
	13	10.8 (24.9)	75/63	40.5	30	49.6	2.88	14		60	46.4	36.4	3.06	4.4
			80/67	43.8	31.2	53	2.89	15.1		70	44.5	33.9	3.25	4
			85/71	47.2	32.2	56.5	2.89	16.3		80	43.3	30.9	3.42	3.7
85	5	1.9 (4.3)	75/63	36.3	28.2	46.4	3.21	11.3	70	60	46.5	36.5	3.07	4.4
			80/67	39.2	29.3	49.5	3.26	12		70	45	34.3	3.26	4
			85/71	42.1	30.2	52.6	3.3	12.8		80	43.5	32.1	3.45	3.7
	9	5.5 (12.6)	75/63	38.3	29.1	48	3.06	12.5		60	50.5	40.2	3.16	4.7
			80/67	41.4	30.2	51.2	3.08	13.4		70	48.7	37.6	3.36	4.2
			85/71	44.6	31.2	54.5	3.1	14.4		80	46.8	35.1	3.56	3.9
	13	10.6 (24.4)	75/63	39.1	29.4	48.6	2.99	13.1		60	52.3	41.9	3.19	4.8
			80/67	42.3	30.5	51.9	3.01	14		70	50.3	39.1	3.4	4.3
			85/71	45.7	31.6	55.3	3.02	15.1		80	48.2	36.3	3.6	3.9
90	5	1.9 (4.3)	75/63	35	27.7	45.4	3.31	10.6	80	60	51.8	41.4	3.18	4.8
			80/67	37.8	28.9	48.3	3.36	11.2		70	50.2	39	3.4	4.3
			85/71	40.5	29.9	51.4	3.41	11.9		80	48.5	36.6	3.61	3.9
	9	5.4 (12.4)	75/63	37	28.5	46.9	3.16	11.7		60	56.2	45.6	3.26	5.1
			80/67	40	29.6	50.1	3.2	12.5		70	54.2	42.8	3.49	4.6
			85/71	43	30.8	53.3	3.22	13.4		80	52.1	39.9	3.71	4.1
	13	10.4 (23.9)	75/63	37.7	28.8	47.5	3.11	12.1		60	58.2	47.5	3.28	5.2
			80/67	40.9	29.9	50.8	3.13	13.1		70	56	44.4	3.52	4.7
			85/71	44	31.1	54.1	3.14	14		80	53.7	41.3	3.75	4.2
100	5	1.8 (4.1)	75/63	32.3	26.7	43.2	3.5	9.2	Extended Range - Anti-freeze required					
			80/67	35	27.6	46.2	3.57	9.8		▶ AHRI/ISO13256-1 certified performance is rated at entering air conditions of 80.6°F DB and 66.2°F WB in cooling and 68°F DB in heating.				
			85/71	37.6	28.7	49.1	3.63	10.4		▶ Tabulated unit performance does not include fan or pump power corrections required for AHRI/ISO standard performance ratings.				
	9	5.2 (11.9)	75/63	34.1	27.2	44.7	3.38	10.1		▶ Unit performance may be interpolated. Extrapolation is not allowed.				
			80/67	37	28.4	47.8	3.42	10.8		▶ For conditions other than rating conditions provided, consult the FHP BST selection software.				
			85/71	39.9	29.7	50.8	3.46	11.5		▶ Ratings below 40°F are with a methanol solution.				
	13	10.1 (23.2)	75/63	34.8	27.5	45.2	3.33	10.5		▶ The results reported herein are estimates based on testing by FHP. Variations in the installation and operational environment may alter performance. Bosch disclaims all warranties, express and implied, that the performance will be as reported, including the warranty of merchantability and fitness for purpose. In addition, continuous research and development may result in a change to an appliances design and specifications, which Bosch may change without notice. Before purchase, confirm the design specifications of the appliance.				
			80/67	37.7	28.9	48.3	3.36	11.2		▶ Continuous research and development				
			85/71	40.9	29.8	51.6	3.39	12		Bosch Thermotechnology Corp.				
110	5	1.8 (4.1)	75/63	29.6	25.3	41	3.69	8	Watertown, MA • Londonderry, NH • Ft. Lauderdale, FL					
			80/67	32	26.7	43.8	3.76	8.5						
			85/71	34.5	27.8	46.6	3.84	9						
	9	5.1 (11.7)	75/63	31.2	26	42.3	3.58	8.7						
			80/67	33.9	27.2	45.3	3.64	9.3						
			85/71	36.6	28.5	48.3	3.7	9.9						
	13	9.8 (22.6)	75/63	31.8	26.5	42.8	3.54	9						
			80/67	34.6	27.5	45.9	3.6	9.6						
			85/71	37.4	28.8	48.9	3.64	10.3						

# Greensource i Series Model SV

## Water Source Heat Pump ½ to 6 Ton



SV042 (1500 CFM) Capacity Data														
Entering Fluid Temp (F)	Water Flow (GPM)	Pressure Drop PSI (FOH)	COOLING						HEATING					
			Entering Air Temp (db/wb) F	Total Capacity (MBTUH)	Sensible Capacity (MBTUH)	Heat of Rejection (MBTUH)	Power Input (kW)	EER	Entering Fluid Temp (F)	Entering Air (F)	Total Capacity (MBTUH)	Heat of Absorption (MBTUH)	Power Input (kW)	COP
50	5	2.1 (4.8)	75/63	45.2	33	53.8	2.72	16.6	30*	60	27.6	19.2	2.61	3.1
			80/67	48.6	34.1	57.3	2.73	17.8		70	26.2	17.6	2.71	2.8
			85/71	52	35.1	60.8	2.73	19		80	25.1	15.9	2.8	2.6
	10	7.4 (17.0)	75/63	48.1	34.2	56.2	2.49	19.3		60	29.8	21.2	2.69	3.2
			80/67	51.7	35.4	59.9	2.48	20.9		70	28.3	19.4	2.8	3
			85/71	55.6	36.2	63.9	2.45	22.7		80	26.9	17.5	2.9	2.7
	13	11.8 (27.0)	75/63	48.8	34.6	56.8	2.44	20		60	30.4	21.8	2.71	3.3
			80/67	52.5	35.7	60.6	2.41	21.7		70	28.9	19.9	2.83	3
			85/71	56.5	36.6	64.6	2.38	23.7		80	26.7	17.9	2.92	2.8
60	5	2 (4.6)	75/63	42.9	32	51.8	2.91	14.7	40*	60	31.9	23	2.77	3.4
			80/67	46.1	33.1	55.2	2.93	15.7		70	30.6	21.4	2.9	3.1
			85/71	49.4	34.1	58.7	2.94	16.8		80	29.4	19.7	3.01	2.9
	10	7.1 (16.3)	75/63	45.6	33.1	54.1	2.69	16.9		60	34.8	25.7	2.86	3.6
			80/67	49.2	34.1	57.8	2.68	18.3		70	33.9	23.4	3	3.3
			85/71	52.8	35.3	61.6	2.67	19.8		80	32	21.7	3.12	3
	13	11.4 (26.2)	75/63	46.2	33.4	54.7	2.64	17.5		60	35.7	26.3	2.88	3.6
			80/67	49.9	34.4	58.5	2.62	19		70	34.6	24	3.02	3.4
			85/71	53.7	35.6	62.3	2.6	20.7		80	32.6	22.3	3.15	3
70	5	2 (4.6)	75/63	40.4	30.9	49.8	3.1	13	50	60	36.7	27.3	2.92	3.7
			80/67	43.5	31.9	53.1	3.13	13.9		70	35.5	25.6	3.07	3.4
			85/71	46.7	32.9	56.6	3.16	14.8		80	34.2	23.6	3.21	3.1
	10	6.9 (15.9)	75/63	43	31.9	52	2.9	14.8		60	40.2	30.7	3.01	3.9
			80/67	46.4	33.1	55.5	2.9	16		70	39.3	28.2	3.17	3.6
			85/71	50	34.1	59.2	2.9	17.3		80	37.1	26.1	3.32	3.3
	13	11.1 (25.6)	75/63	43.6	32.2	52.5	2.85	15.3		60	41.8	31.1	3.04	4
			80/67	47.1	33.4	56.1	2.85	16.5		70	40.2	28.9	3.2	3.7
			85/71	50.8	34.4	59.9	2.83	17.9		80	38	26.7	3.35	3.3
80	5	1.9 (4.3)	75/63	37.9	29.7	47.7	3.3	11.5	60	60	41.8	32	3.05	4
			80/67	40.9	30.8	51	3.35	12.2		70	40.6	30.1	3.23	3.7
			85/71	43.8	32	54.1	3.38	13		80	39.7	27.9	3.4	3.4
	10	6.7 (15.4)	75/63	40.3	30.7	49.7	3.12	12.9		60	46	36.1	3.15	4.3
			80/67	43.6	31.8	53.2	3.13	13.9		70	45	33.2	3.33	4
			85/71	47	33	56.8	3.14	15		80	43.3	30.9	3.52	3.6
	13	10.7 (24.7)	75/63	40.9	31	50.2	3.07	13.3		60	47.8	36.5	3.17	4.4
			80/67	44.3	32.1	53.8	3.08	14.4		70	46	34.1	3.36	4
			85/71	47.7	33.3	57.4	3.07	15.5		80	45.2	30.6	3.54	3.7
85	5	1.9 (4.3)	75/63	36.6	29.1	46.6	3.4	10.7	70	60	47.1	36.9	3.17	4.4
			80/67	39.4	30.5	49.7	3.45	11.4		70	45.8	34.8	3.37	4
			85/71	42.4	31.3	53	3.49	12.1		80	44.9	32.4	3.57	3.7
	10	6.6 (15.2)	75/63	38.9	30.1	48.6	3.23	12		60	52.5	41.1	3.25	4.7
			80/67	42	31.4	51.9	3.25	12.9		70	50.8	38.5	3.47	4.3
			85/71	45.3	32.6	55.4	3.26	13.9		80	48.9	35.9	3.68	3.9
	13	10.5 (24.2)	75/63	39.5	30.3	49.1	3.18	12.4		60	53.9	42.3	3.27	4.8
			80/67	42.7	31.7	52.5	3.2	13.4		70	52	39.5	3.49	4.4
			85/71	46.1	32.8	56	3.2	14.4		80	51.1	35.5	3.71	4
90	5	1.9 (4.3)	75/63	35.1	28.7	45.4	3.5	10	80	60	52.5	42.1	3.26	4.7
			80/67	38	29.9	48.5	3.55	10.7		70	50.9	39.8	3.49	4.3
			85/71	40.9	30.8	51.8	3.6	11.4		80	49.3	37.2	3.71	3.9
	10	6.5 (14.9)	75/63	37.5	29.4	47.4	3.34	11.2		60	58.5	46.8	3.33	5.2
			80/67	40.6	30.7	50.8	3.36	12.1		70	56.6	43.9	3.57	4.6
			85/71	43.8	31.8	54.2	3.38	13		80	54.6	41	3.81	4.2
	13	10.4 (23.9)	75/63	38	29.7	47.9	3.3	11.5		60	59.5	48.7	3.34	5.2
			80/67	41.2	30.9	51.3	3.32	12.4		70	57.9	45.1	3.59	4.7
			85/71	44.5	32.1	54.8	3.33	13.4		80	56.9	40.5	3.83	4.4
100	5	1.8 (4.1)	75/63	32.5	27.5	43.1	3.69	8.8	80	* Extended Range - Anti-freeze required				
			80/67	35.1	28.8	46.1	3.76	9.3		▶ AHRI/ISO13256-1 certified performance is rated at entering air conditions of 80.6°F DB and 66.2°F WB in cooling and 68°F DB in heating.				
			85/71	37.9	29.7	49.2	3.82	9.9		▶ Tabulated unit performance does not include fan or pump power corrections required for AHRI/ISO standard performance ratings.				
	10	6.3 (14.5)	75/63	34.5	28.4	44.9	3.55	9.7		▶ Unit performance may be interpolated. Extrapolation is not allowed.				
			80/67	37.5	29.7	48.1	3.59	10.4		▶ For conditions other than rating conditions provided, consult the FHP BST selection software.				
			85/71	40.6	30.7	51.5	3.63	11.2		▶ Ratings below 40°F are with a methanol solution.				
	13	10.1 (23.2)	75/63	35	28.6	45.3	3.51	10		▶ The results reported herein are estimates based on testing by FHP. Variations in the installation and operational environment may alter performance. Bosch disclaims all warranties, express and implied, that the performance will be as reported, including the warranty of merchantability and fitness for purpose. In addition, continuous research and development may result in a change to an appliances design and specifications, which Bosch may change without notice. Before purchase, confirm the design specifications of the appliance.				
			80/67	38	29.9	48.6	3.55	10.7		▶ Continuous research and development by Bosch Thermotechnology Corp. change				
			85/71	41.2	30.9	52	3.58	11.5		Watertown, MA • Londonderry, NH • Ft. Lauderdale, FL				
110	5	1.8 (4.1)	75/63	29.7	26.2	40.7	3.88	7.7						
			80/67	32.2	27.4	43.6	3.96	8.1						
			85/71	34.7	28.6	46.6	4.03	8.6						
	10	6.1 (14.0)	75/63	31.5	27.2	42.3	3.76	8.4						
			80/67	34.3	28.5	45.4	3.82	9						
			85/71	37.1	29.7	48.6	3.86	9.6						
	13	9.8 (22.6)	75/63	32	27.3	42.7	3.73	8.6						
			80/67	34.8	28.7	45.8	3.78	9.2						
			85/71	37.8	29.7	49.1	3.82	9.9						

# Greensource i Series Model SV

## Water Source Heat Pump 1/2 to 6 Ton



# BOSCH

SV048 (1600 CFM) Capacity Data														
COOLING									HEATING					
Entering Fluid Temp (F)	Water Flow (GPM)	Pressure Drop PSI (FOH)	Entering Air Temp (db/wb) F	Total Capacity (MBTUH)	Sensible Capacity (MBTUH)	Heat of Rejection (MBTUH)	Power Input (kW)	EER	Entering Fluid Temp (F)	Entering Air Temp (F)	Total Capacity (MBTUH)	Heat of Absorption (MBTUH)	Power Input (kW)	COP
50	6	0.9 (2.0)	75/63	52.8	38	62.5	2.95	17.9	30*	60	34.3	25.4	2.69	3.7
			80/67	56.3	39.1	66	2.97	19		70	32	22.6	2.79	3.4
			85/71	59.9	40.1	69.8	2.99	20.1		80	29.8	19.6	2.89	3
	12	3 (6.9)	75/63	56.5	39.7	65.2	2.63	21.5		60	36.9	27.5	2.81	3.8
			80/67	60.3	40.7	68.9	2.61	23.1		70	34.4	24.9	2.92	3.4
			85/71	64.3	41.6	72.9	2.58	24.9		80	32	21.9	3.02	3.1
	16	5.1 (11.7)	75/63	57.5	40.1	65.9	2.54	22.7		60	37.7	28.2	2.85	3.9
			80/67	61.4	41.1	69.8	2.51	24.5		70	35.2	25.5	2.96	3.5
			85/71	65.5	42.1	73.8	2.46	26.6		80	32.6	22.6	3.06	3.1
60	6	0.8 (1.8)	75/63	49.9	36.8	60.3	3.19	15.6	40*	60	38.5	28.9	2.88	3.9
			80/67	53.3	37.9	63.8	3.23	16.5		70	36.5	26.5	3.02	3.5
			85/71	56.9	39	67.5	3.26	17.5		80	34.4	23.5	3.14	3.2
	12	2.9 (6.6)	75/63	53.4	38.3	62.9	2.91	18.4		60	41.8	31.8	3.01	4.1
			80/67	57.1	39.3	66.6	2.9	19.7		70	39.6	29.3	3.16	3.7
			85/71	61	40.4	70.6	2.89	21.1		80	37.3	26.5	3.29	3.3
	16	4.9 (11.3)	75/63	54.3	38.6	63.6	2.83	19.2		60	42.9	32.7	3.05	4.1
			80/67	58.1	39.7	67.4	2.81	20.7		70	40.6	30.2	3.2	3.7
			85/71	62.1	40.8	71.4	2.79	22.3		80	38.2	27.2	3.33	3.4
70	6	0.8 (1.8)	75/63	46.9	35.5	57.9	3.43	13.7	50	60	43.5	33.3	3.07	4.1
			80/67	50.3	36.6	61.6	3.48	14.5		70	41.5	30.7	3.23	3.8
			85/71	53.8	37.7	65.2	3.52	15.3		80	39.3	28.3	3.38	3.4
	12	2.8 (6.4)	75/63	50.2	36.8	60.5	3.18	15.8		60	47.4	36.5	3.21	4.3
			80/67	53.8	38	64.2	3.19	16.9		70	45.3	33.7	3.37	3.9
			85/71	57.6	39.1	68.1	3.19	18		80	43.2	31	3.54	3.6
	16	4.7 (10.8)	75/63	51	37.1	61.1	3.11	16.4		60	48.7	37.5	3.24	4.4
			80/67	54.7	38.3	64.9	3.11	17.6		70	46.6	35.5	3.42	4
			85/71	58.7	39.5	68.9	3.1	18.9		80	44.3	32.3	3.59	3.6
80	6	0.8 (1.8)	75/63	43.9	34.1	55.6	3.67	12	60	60	48.8	37.8	3.25	4.4
			80/67	47.2	35.2	59.2	3.73	12.7		70	47	35.3	3.43	4
			85/71	50.5	36.7	62.7	3.78	13.4		80	45.3	32.8	3.62	3.7
	12	2.7 (6.2)	75/63	46.8	35.3	57.9	3.44	13.6		60	53.7	42.2	3.39	4.6
			80/67	50.4	36.5	61.7	3.47	14.5		70	51.6	39.2	3.59	4.2
			85/71	54.2	37.7	65.6	3.49	15.5		80	49.5	37	3.79	3.8
	16	4.6 (10.6)	75/63	47.6	35.6	58.5	3.38	14.1		60	55.2	44	3.43	4.7
			80/67	51.3	36.9	62.3	3.4	15.1		70	53	41.1	3.64	4.3
			85/71	55.1	38	66.3	3.41	16.2		80	50.8	38.3	3.84	3.9
85	6	0.8 (1.8)	75/63	42.3	33.3	54.4	3.78	11.2	70	60	54.6	43.2	3.41	4.7
			80/67	45.5	34.9	57.8	3.85	11.8		70	52.8	40.7	3.63	4.3
			85/71	48.9	35.7	61.6	3.92	12.5		80	51	38.1	3.84	3.9
	12	2.7 (6.2)	75/63	45.2	34.5	56.6	3.57	12.7		60	60.3	48.3	3.56	5
			80/67	48.7	35.8	60.4	3.61	13.5		70	58.2	45.2	3.79	4.5
			85/71	52.3	37.2	64.2	3.64	14.4		80	56	42.8	4.02	4.1
	16	4.5 (10.3)	75/63	45.9	34.9	57.2	3.51	13.1		60	62.1	50.4	3.6	5.1
			80/67	49.5	36.1	61	3.54	14		70	59.8	47.3	3.84	4.6
			85/71	53.3	37.5	64.9	3.56	15		80	57.5	44.3	4.07	4.1
90	6	0.8 (1.8)	75/63	40.7	32.9	53.1	3.9	10.5	80	60	60.7	48.9	3.57	5
			80/67	44	33.9	56.7	3.98	11.1		70	58.9	46.2	3.81	4.5
			85/71	47.3	35.2	60.3	4.05	11.7		80	57	43.5	4.06	4.1
	12	2.6 (5.9)	75/63	43.5	33.7	55.3	3.7	11.8		60	67.3	54.7	3.7	5.3
			80/67	46.9	35.3	59	3.75	12.5		70	65	51.4	3.97	4.8
			85/71	50.6	36.3	62.9	3.79	13.4		80	62.8	48.1	4.23	4.4
	16	4.4 (10.1)	75/63	44.2	34.1	55.9	3.65	12.1		60	70	56.7	3.74	5.5
			80/67	47.7	35.6	59.6	3.68	13		70	66.8	53.8	4.02	4.9
			85/71	51.5	36.7	63.5	3.72	13.9		80	64.3	50.5	4.28	4.4
100	6	0.7 (1.6)	75/63	37.5	31.5	50.6	4.12	9.1	Extended Range - Anti-freeze required					
			80/67	40.6	32.9	54.1	4.22	9.6						
			85/71	43.7	34.2	57.6	4.31	10.2						
	12	2.6 (5.9)	75/63	40	32.3	52.6	3.95	10.1		▶ AHRI/ISO13256-1 certified performance is rated at entering air conditions of 80.6°F DB and 66.2°F WB in cooling and 68°F DB in heating.				
			80/67	43.3	33.9	56.2	4.02	10.8		▶ Tabulated unit performance does not include fan or pump power corrections required for AHRI/ISO standard performance ratings.				
			85/71	46.9	35	60	4.08	11.5		▶ Unit performance may be interpolated. Extrapolation is not allowed.				
	16	4.3 (9.9)	75/63	40.6	32.6	53.1	3.91	10.4		▶ For conditions other than rating conditions provided, consult the FHP BST selection software.				
			80/67	44	34.2	56.7	3.96	11.1		▶ Ratings below 40°F are with a methanol solution.				
			85/71	47.7	35.3	60.7	4.02	11.9		▶ The results reported herein are estimates based on testing by FHP. Variations in the installation and operational environment may alter performance. Bosch disclaims all warranties, express and implied, that the performance will be as reported, including the warranty of merchantability and fitness for purpose. In addition, continuous research and development may result in a change to an appliances design and specifications, which Bosch may change without notice. Before purchase, confirm the design specifications of the appliance.				
110	6	0.7 (1.6)	75/63	34.4	30.2	48.2	4.35	7.9						
			80/67	37.2	31.7	51.4	4.46	8.3						
			85/71	40.2	33	54.8	4.57	8.8						
	12	2.5 (5.7)	75/63	36.5	30.9	49.8	4.2	8.7						
			80/67	39.6	32.5	53.3	4.29	9.2						
			85/71	43	34	57	4.36	9.9						
	16	4.2 (9.6)	75/63	37	31.1	50.2	4.17	8.9						
			80/67	40.3	32.5	53.9	4.25	9.5						
			85/71	43.7	34.3	57.5	4.31	10.2						

\* Extended Range - Anti-freeze required

▶ AHRI/ISO13256-1 certified performance is rated at entering air conditions of 80.6°F DB and 66.2°F WB in cooling and 68°F DB in heating.

▶ Tabulated unit performance does not include fan or pump power corrections required for AHRI/ISO standard performance ratings.

▶ Unit performance may be interpolated. Extrapolation is not allowed.

▶ For conditions other than rating conditions provided, consult the FHP BST selection software.

▶ Ratings below 40°F are with a methanol solution.

▶ The results reported herein are estimates based on testing by FHP. Variations in the installation and operational environment may alter performance. Bosch disclaims all warranties, express and implied, that the performance will be as reported, including the warranty of merchantability and fitness for purpose. In addition, continuous research and development may result in a change to an appliances design and specifications, which Bosch may change without notice. Before purchase, confirm the design specifications of the appliance.

▶ Continuous research and development by Bosch Thermotechnology Corp. may result in a change



# Greensource i Series Model SV

## Water Source Heat Pump 1/2 to 6 Ton



### SV060 (2000 CFM) Capacity Data

COOLING										HEATING				
Entering Fluid Temp (F)	Water Flow (GPM)	Pressure Drop PSI (FOH)	Entering Air Temp (db/wb) F	Total Capacity (MBTUH)	Sensible Capacity (MBTUH)	Heat of Rejection (MBTUH)	Power Input (kW)	EER	Entering Fluid Temp (F)	Entering Air Temp (F)	Total Capacity (MBTUH)	Heat of Absorption (MBTUH)	Power Input (kW)	COP
50	8	1.7 (3.9)	75/63	65.6	47	77.2	3.52	18.7	30*	60	45.2	30.8	3.98	3.3
			80/67	70	48.3	81.8	3.56	19.7		70	45.7	27.9	4.35	3.1
			85/71	74.5	49.6	86.6	3.62	20.6		80	44.4	27	4.77	2.7
	13	4 (9.2)	75/63	67.6	47.9	78.5	3.28	20.6		60	47.4	32.6	4.03	3.4
			80/67	72.2	49.2	83.3	3.31	21.8		70	47.4	30	4.4	3.2
			85/71	77.1	50.5	88.3	3.35	23.1		80	46.9	27.9	4.81	2.9
	20	8.6 (19.8)	75/63	68.7	48.4	79.2	3.14	21.9		60	48.8	33.7	4.06	3.5
			80/67	73.5	49.8	84.1	3.16	23.2		70	48.2	31.4	4.43	3.2
			85/71	78.6	51.1	89.3	3.19	24.7		80	46.6	30.2	4.84	2.8
60	8	1.6 (3.6)	75/63	63	45.9	75.6	3.83	16.5	40*	60	49.7	35.9	4.1	3.6
			80/67	67.2	47.2	80.1	3.88	17.3		70	51.5	33	4.48	3.4
			85/71	71.7	48.5	84.7	3.93	18.2		80	49.9	32	4.91	3
	13	3.8 (8.7)	75/63	64.9	46.7	76.8	3.59	18.1		60	53.7	38.3	4.16	3.8
			80/67	69.4	48.1	81.5	3.62	19.2		70	52.9	36.2	4.54	3.4
			85/71	74.2	49.3	86.4	3.66	20.3		80	53	33.4	4.96	3.1
	20	8.3 (19.1)	75/63	66	47.2	77.5	3.46	19.1		60	54.8	41	4.2	3.8
			80/67	70.7	48.6	82.3	3.48	20.3		70	54.6	37.5	4.57	3.5
			85/71	75.6	49.9	87.3	3.51	21.6		80	53.9	35.2	5	3.2
70	8	1.5 (3.4)	75/63	60.2	44.7	74	4.17	14.4	50	60	57.4	41.8	4.23	4
			80/67	64.4	46.1	78.3	4.22	15.3		70	55.7	40	4.62	3.5
			85/71	68.7	47.2	82.9	4.28	16.1		80	55.1	37.8	5.06	3.2
	13	3.7 (8.5)	75/63	62.1	45.5	75.1	3.93	15.8		60	60.7	44.8	4.3	4.1
			80/67	66.5	46.8	79.7	3.96	16.8		70	59.8	42.4	4.69	3.7
			85/71	71.1	48.1	84.4	4	17.8		80	58.9	39.9	5.13	3.4
	20	8.1 (18.6)	75/63	63.2	46	75.8	3.8	16.6		60	62.9	46.6	4.34	4.2
			80/67	67.7	47.3	80.4	3.82	17.7		70	61.8	44	4.74	3.8
			85/71	72.5	48.6	85.3	3.85	18.8		80	60.8	41.2	5.18	3.4
80	8	1.5 (3.4)	75/63	57.4	43.5	72.4	4.56	12.6	60	60	64.2	48.2	4.37	4.3
			80/67	61.5	44.8	76.6	4.61	13.4		70	63.4	45.8	4.78	3.9
			85/71	65.6	45.9	81	4.66	14.1		80	61.6	43.8	5.23	3.5
	13	3.6 (8.3)	75/63	59.3	44.2	73.4	4.31	13.8		60	68.3	51.7	4.46	4.5
			80/67	63.5	45.6	77.8	4.34	14.6		70	67.1	49	4.87	4
			85/71	67.9	46.8	82.4	4.38	15.5		80	66.1	46.3	5.32	3.6
	20	7.8 (17.9)	75/63	60.2	44.6	74	4.17	14.4		60	70.2	55.1	4.53	4.5
			80/67	64.6	46	78.5	4.2	15.4		70	68.5	51.4	4.93	4.1
			85/71	69.2	47.3	83.2	4.22	16.4		80	68.3	48.1	5.38	3.7
85	8	1.5 (3.4)	75/63	56	42.7	71.7	4.77	11.8	70	60	72.7	54.2	4.54	4.7
			80/67	60	44.1	75.8	4.82	12.5		70	71.7	51.6	4.95	4.2
			85/71	64	45.5	80	4.87	13.1		80	69.5	49.6	5.42	3.8
	13	3.5 (8.0)	75/63	57.8	43.5	72.6	4.51	12.8		60	76.2	59	4.65	4.8
			80/67	62	44.9	76.9	4.55	13.6		70	74.8	56	5.07	4.3
			85/71	66.3	46.1	81.5	4.58	14.5		80	73.5	53	5.53	3.9
	20	7.7 (17.7)	75/63	58.7	43.9	73.1	4.38	13.4		60	79.3	61.6	4.73	4.9
			80/67	63	45.4	77.6	4.4	14.3		70	76.6	58.8	5.15	4.4
			85/71	67.5	46.6	82.2	4.43	15.3		80	75	55.4	5.61	3.9
90	8	1.5 (3.4)	75/63	54.6	42.1	70.9	4.99	10.9	80	60	79.2	61.9	4.73	4.9
			80/67	58.5	43.4	75	5.04	11.6		70	79.1	58.3	5.15	4.5
			85/71	62.4	44.7	79.2	5.1	12.2		80	76.7	56	5.63	4
	13	3.5 (8.0)	75/63	56.3	42.8	71.8	4.73	11.9		60	84.5	66.6	4.87	5.1
			80/67	60.4	44.2	76.1	4.76	12.7		70	82.8	63.2	5.3	4.6
			85/71	64.5	45.8	80.3	4.8	13.5		80	81.3	59.9	5.77	4.1
	20	7.6 (17.5)	75/63	57.2	43.2	72.3	4.6	12.4		60	88	69.5	4.97	5.2
			80/67	61.4	44.7	76.6	4.62	13.3		70	85	66.4	5.39	4.6
			85/71	65.7	46.2	81.1	4.64	14.2		80	83	62.6	5.86	4.1
100	8	1.4 (3.2)	75/63	51.7	40.7	69.6	5.49	9.4	* Extended Range - Anti-freeze required					
			80/67	55.3	42.2	73.5	5.54	10						
			85/71	59.1	43.5	77.4	5.59	10.6						
	13	3.4 (7.8)	75/63	53.2	41.4	70.3	5.22	10.2		▶ AHRI/ISO13256-1 certified performance is rated at entering air conditions of 80.6°F DB and 66.2°F WB in cooling and 68°F DB in heating.				
			80/67	57.1	42.9	74.4	5.25	10.9		▶ Tabulated unit performance does not include fan or pump power corrections required for AHRI/ISO standard performance ratings.				
			85/71	61.2	44.2	78.5	5.28	11.6		▶ Unit performance may be interpolated. Extrapolation is not allowed.				
	20	7.3 (16.8)	75/63	54.1	41.8	70.7	5.08	10.6		▶ For conditions other than rating conditions provided, consult the FHP BST selection software.				
			80/67	58	43.5	74.7	5.1	11.4		▶ Ratings below 40°F are with a methanol solution.				
			85/71	62.2	44.9	79	5.12	12.2		▶ The results reported herein are estimates based on testing by FHP. Variations in the installation and operational environment may alter performance. Bosch disclaims all warranties, express and implied, that the performance will be as reported, including the warranty of merchantability and fitness for purpose. In addition, continuous research and development may result in a change to an appliances design and specifications, which Bosch may change without notice. Before purchase, confirm the design specifications of the appliance.				
110	8	1.4 (3.2)	75/63	48.5	39.4	68.4	6.08	8	▶ Continuous research and development by Bosch Thermotechnology Corp. change					
			80/67	52	40.9	72.1	6.12	8.5	Watertown, MA • Londonderry, NH • Ft. Lauderdale, FL					
			85/71	55.6	42.3	75.8	6.17	9						
	13	3.3 (7.6)	75/63	50	40	68.9	5.79	8.6						
			80/67	53.6	41.8	72.7	5.81	9.2						
			85/71	57.4	43.3	76.6	5.84	9.8						
	20	7.1 (16.3)	75/63	50.7	40.5	69.1	5.65	9						
			80/67	54.5	42.2	73	5.65	9.6						
			85/71	58.4	43.7	77.1	5.67	10.3						

# Greensource i Series Model SV

## Water Source Heat Pump ½ to 6 Ton



SV070 (2200 CFM) Capacity Data														
Entering Fluid Temp (F)	Water Flow (GPM)	Pressure Drop PSI (FOH)	COOLING					HEATING						
			Entering Air Temp (db/wb) F	Total Capacity (MBTUH)	Sensible Capacity (MBTUH)	Heat of Rejection (MBTUH)	Power Input (kW)	EER	Entering Fluid Temp (F)	Entering Air (F)	Total Capacity (MBTUH)	Heat of Absorption (MBTUH)	Power Input (kW)	COP
50	10	2.6 (5.9)	75/63	72.2	53.9	85.4	3.96	18.3	30*	60	49.4	35.1	4.19	3.5
			80/67	77.1	55.5	90.5	4.01	19.3		70	49.4	32.6	4.56	3.2
			85/71	82.2	57	95.9	4.06	20.2		80	48.8	30.5	4.97	2.9
	15	5.4 (12.4)	75/63	74	54.7	86.6	3.76	19.7		60	51.3	36.8	4.23	3.6
			80/67	79.2	56.3	91.9	3.8	20.9		70	50.2	34.6	4.59	3.2
			85/71	84.5	57.9	97.4	3.84	22		80	49.4	32.4	5	2.9
	20	9.1 (20.9)	75/63	74.9	55.1	87.2	3.66	20.5		60	52.1	37.7	4.24	3.6
			80/67	80.2	56.7	92.6	3.69	21.8		70	51.1	35.5	4.6	3.3
			85/71	85.7	58.3	98.2	3.72	23		80	50	32.9	5.01	2.9
60	10	2.5 (5.7)	75/63	69.2	52.5	83.5	4.29	16.1	40*	60	55.7	41	4.3	3.8
			80/67	74	54.2	88.4	4.34	17.1		70	55.6	38.3	4.66	3.5
			85/71	78.9	55.8	93.6	4.39	18		80	54.9	36.1	5.08	3.2
	15	5.2 (11.9)	75/63	71	53.3	84.6	4.09	17.3		60	57.9	43.2	4.33	3.9
			80/67	75.9	55	89.7	4.13	18.4		70	56.8	40.9	4.7	3.5
			85/71	81	56.9	95	4.17	19.4		80	55.9	38.5	5.12	3.2
	20	8.7 (20.0)	75/63	71.8	53.7	85.2	4	18		60	59.2	44.5	4.35	4
			80/67	76.9	55.4	90.4	4.03	19.1		70	58	42	4.72	3.6
			85/71	82.1	57.3	95.7	4.06	20.2		80	56.9	39.3	5.14	3.2
70	10	2.4 (5.5)	75/63	66.1	51.2	81.5	4.65	14.2	50	60	62.6	47.7	4.4	4.2
			80/67	70.6	52.9	86.2	4.7	15		70	61.6	45.6	4.78	3.8
			85/71	75.4	54.5	91.2	4.76	15.9		80	60.8	42.9	5.21	3.4
	15	5 (11.5)	75/63	67.7	51.9	82.5	4.45	15.2		60	65.5	50.5	4.45	4.3
			80/67	72.4	53.9	87.4	4.49	16.1		70	64.2	47.8	4.83	3.9
			85/71	77.5	55.3	92.7	4.53	17.1		80	63.1	45.2	5.26	3.5
	20	8.5 (19.6)	75/63	68.5	52.5	82.9	4.35	15.7		60	67.1	52	4.47	4.4
			80/67	73.4	54.3	88	4.38	16.8		70	65.7	49.2	4.86	4
			85/71	78.5	56	93.3	4.42	17.8		80	64.4	46.4	5.28	3.6
80	10	2.4 (5.5)	75/63	62.8	49.8	79.5	5.05	12.4	60	60	71.1	54.5	4.53	4.6
			80/67	67.2	51.6	84.1	5.1	13.2		70	69.1	52.7	4.92	4.1
			85/71	71.6	53.6	88.7	5.15	13.9		80	67.6	49.5	5.35	3.7
	15	4.9 (11.3)	75/63	64.3	50.7	80.3	4.85	13.3		60	73.7	58.3	4.59	4.7
			80/67	68.9	52.6	85.1	4.88	14.1		70	72.2	55.3	4.98	4.2
			85/71	73.6	54.3	90	4.92	15		80	70.8	52.4	5.42	3.8
	20	8.2 (18.9)	75/63	65.1	51.1	80.8	4.75	13.7		60	75.8	60.2	4.62	4.8
			80/67	69.8	52.9	85.7	4.78	14.6		70	73.6	57	5.01	4.3
			85/71	74.7	54.7	90.7	4.81	15.5		80	72.4	53.8	5.45	3.9
85	10	2.3 (5.3)	75/63	61	49.4	78.4	5.27	11.6	70	60	79.3	62.2	4.67	5
			80/67	65.3	51.2	82.9	5.32	12.3		70	76.8	59.5	5.07	4.4
			85/71	69.7	52.9	87.5	5.37	13		80	75.4	56.4	5.52	4
	15	4.8 (11.0)	75/63	62.7	49.8	79.4	5.07	12.4		60	82.7	66.6	4.75	5.1
			80/67	67.2	51.6	84.1	5.1	13.2		70	80.4	63.4	5.15	4.6
			85/71	71.7	53.6	88.8	5.14	14		80	80	59	5.6	4.2
	20	8.1 (18.6)	75/63	63.5	50.1	79.9	4.97	12.8		60	84.8	68.7	4.79	5.2
			80/67	68.1	51.9	84.6	5	13.6		70	82.8	64.6	5.2	4.7
			85/71	72.7	54	89.4	5.02	14.5		80	80.4	61.7	5.64	4.2
90	10	2.3 (5.3)	75/63	59.5	48.4	77.6	5.51	10.8	80	60	87.9	70.2	4.84	5.3
			80/67	63.5	50.5	81.9	5.55	11.4		70	85	67.3	5.25	4.7
			85/71	68	51.9	86.6	5.61	12.1		80	83.8	64.1	5.71	4.3
	15	4.7 (10.8)	75/63	60.8	49.3	78.3	5.29	11.5		60	92	75.2	4.94	5.5
			80/67	65.4	50.9	83	5.33	12.3		70	89.2	71.7	5.35	4.9
			85/71	69.8	52.9	87.6	5.37	13		80	88.5	66.8	5.81	4.5
	20	7.9 (18.2)	75/63	61.6	49.6	78.7	5.19	11.9		60	94.3	77.6	4.99	5.5
			80/67	66.1	51.5	83.4	5.22	12.7		70	91.9	73.9	5.41	5
			85/71	70.9	52.9	88.3	5.26	13.5		80	89.2	69.8	5.86	4.5
100	10	2.2 (5.0)	75/63	55.9	47.4	75.7	6.02	9.3	Extended Range - Anti-freeze required	▶ AHRI/ISO13256-1 certified performance is rated at entering air conditions of 80.6°F DB and 66.2°F WB in cooling and 68°F DB in heating.				
			80/67	59.9	49.2	79.9	6.07	9.9		▶ Tabulated unit performance does not include fan or pump power corrections required for AHRI/ISO standard performance ratings.				
			85/71	64.1	50.6	84.3	6.13	10.5		▶ Unit performance may be interpolated. Extrapolation is not allowed.				
	15	4.6 (10.6)	75/63	57.3	47.8	76.4	5.81	9.9		▶ For conditions other than rating conditions provided, consult the FHP BST selection software.				
			80/67	61.5	49.8	80.7	5.84	10.5		▶ Ratings below 40°F are with a methanol solution.				
			85/71	65.8	51.5	85.2	5.87	11.2		▶ The results reported herein are estimates based on testing by FHP. Variations in the installation and operational environment may alter performance. Bosch disclaims all warranties, express and implied, that the performance will be as reported, including the warranty of merchantability and fitness for purpose. In addition, continuous research and development may result in a change to an appliances design and specifications, which Bosch may change without notice. Before purchase, confirm the design specifications of the appliance.				
	20	7.7 (17.7)	75/63	57.9	48.1	76.7	5.71	10.2		▶ Continuous research and development by Bosch Thermotechnology Corp. change				
			80/67	62.2	50.3	81.1	5.72	10.9		Watertown, MA • Londonderry, NH • Ft. Lauderdale, FL				
			85/71	66.8	51.5	85.9	5.76	11.6						
110	10	2.1 (4.8)	75/63	52.3	45.8	74.1	6.64	7.9						
			80/67	56	47.8	78	6.68	8.4						
			85/71	59.9	49.5	82.1	6.73	8.9						
	15	4.5 (10.3)	75/63	53.7	46.1	74.8	6.41	8.4						
			80/67	57.7	48	78.9	6.43	9						
			85/71	61.6	50.3	82.9	6.46	9.5						
	20	7.5 (17.2)	75/63	54.2	46.7	74.9	6.3	8.6						
			80/67	58.3	48.5	79.1	6.32	9.2						
			85/71	62.5	50.3	83.4	6.34	9.9						

**GreenSource** i Series Model SV  
Water Source Heat Pump ½ to 6 Ton



**BOSCH**

Antifreeze Correction							
Antifreeze Type	Antifreeze %	Cooling			Heating		WPD Correction Factor EWT 30 °F
		EWT 90 Deg.F			EWT 30 Deg. F		
		Total Cap.	Sens. Cap	Power	Htg. Cap	Power	
<b>Water</b>	0	1.000	1.000	1.000	1.000	1.000	1.000
<b>Propylene Glycol</b>	5	0.997	0.997	1.004	0.989	0.997	1.060
	10	0.994	0.994	1.006	0.986	0.995	1.125
	15	0.990	0.990	1.009	0.978	0.988	1.190
	25	0.983	0.983	1.016	0.960	0.979	1.300
	5	0.997	0.997	1.003	0.990	0.997	1.060
<b>Methanol</b>	10	0.996	0.996	1.005	0.979	0.993	1.100
	15	0.994	0.994	1.008	0.970	0.990	1.140
	5	0.998	0.998	1.002	0.981	0.994	1.160
<b>Ethanol</b>	10	0.996	0.996	1.004	0.960	0.988	1.230
	15	0.992	0.992	1.006	0.944	0.983	1.280
	25	0.986	0.986	1.009	0.917	0.974	1.400
	5	0.997	0.997	1.003	0.993	0.998	1.060
<b>Ethylene Glycol</b>	10	0.995	0.995	1.004	0.986	0.996	1.120
	15	0.992	0.992	1.005	0.980	0.993	1.190
	25	0.988	0.988	1.009	0.970	0.990	1.330
	30	0.985	0.985	1.012	0.965	0.987	1.400

# Greensource i Series Model SV

## Water Source Heat Pump ½ to 6 Ton



# BOSCH

Casing Radiated Sound Power - Octave Band Sound Power Levels dB, re 10-12 Watts										
Model	Load	Center Frequency - Hz								Overall (dBA)
		63	125	250	500	1000	2000	4000	8000	
SV007-1VTC	Cooling Full	73	58	55	49	45	37	31	29	53*
	Heating Full	79	59	54	48	45	37	32	34	55
	FAN Only	70	57	51	47	43	36	28	26	50*
SV009-1VTC	Cooling Full	74	57	58	49	46	39	32	30	54*
	Heating Full	72	57	55	48	45	37	31	29	52*
	FAN Only	67	54	49	46	43	38	31	29	49*
SV012-1VTC	Cooling Full	73	64	58	50	46	40	34	29	55
	Heating Full	73	64	61	50	46	39	35	31	56
	FAN Only	73	61	55	49	45	39	33	30	53
SV015-1VTC	Cooling Full	78	60	56	50	47	42	41	38	56*
	Heating Full	79	62	55	50	46	42	37	35	56
	FAN Only	73	58	52	49	45	41	35	31	53
SV018-1VTC	Cooling Full	68	65	56	52	52	48	38	31	56
	Heating Full	72	65	56	53	51	46	38	34	57*
	FAN Only	66	61	52	49	49	42	34	26	53
SV024-1VTC	Cooling Full	82	63	59	55	53	47	43	35	60
	Heating Full	79	70	58	54	53	48	46	39	60
	FAN Only	72	60	54	53	51	44	36	29	55
SV030-1VTC	Cooling Full	84	64	57	54	53	52	42	35	61
	Heating Full	80	81	57	55	53	49	44	39	66
	FAN Only	68	58	56	53	51	47	39	32	56
SV036-1VTC	Cooling Full	74	63	65	57	56	50	43	37	61
	Heating Full	74	76	65	58	56	53	46	42	64
	FAN Only	69	60	58	56	56	49	41	32	59
SV041-1VTC	Cooling Full	79	65	63	57	54	51	47	42	61
	Heating Full	77	71	59	59	54	51	46	43	61
	FAN Only	75	63	57	55	52	49	44	38	58
SV042-1VTC	Cooling Full	80	67	63	56	52	48	47	40	61
	Heating Full	77	73	60	56	54	49	47	41	61
	FAN Only	70	67	57	54	51	47	39	33	57

\* Denotes background noise level is too high for the A-weighted value to be valid. Actual levels are less than or equal to stated values.

# Greensource i Series Model SV

## Water Source Heat Pump ½ to 6 Ton



# BOSCH

Casing Radiated Sound Power Continued - Octave Band Sound Power Levels dB, re 10-12 Watts										
Model	Load	Center Frequency - Hz								Overall (dBA)
		63	125	250	500	1000	2000	4000	8000	
SV048-1VTC	Cooling Full	80	64	62	59	60	55	46	39	64
	Heating Full	76	67	63	60	61	56	47	41	64
	FAN Only	78	65	61	58	60	55	47	39	64
SV060-1VTC	Cooling Full	74	72	64	59	58	54	45	36	63
	Heating Full	82	73	67	59	57	53	47	40	64
	FAN Only	71	70	60	58	57	53	44	36	62
SV070-1VTC	Cooling Full	80	67	62	59	54	49	43	37	62
	Heating Full	81	68	64	57	53	50	44	39	61
	FAN Only	73	65	60	55	53	49	43	37	59
SV012-1HZC	Cooling Full	84	61	55	48	47	42	40	35	59
	Heating Full	85	62	56	49	47	43	40	38	60
	FAN Only	67	54	51	47	46	40	34	30	51
SV024-1HZC	Cooling Full	80	62	59	56	54	48	43	37	60
	Heating Full	81	63	59	55	54	48	44	41	60
	FAN Only	68	59	58	54	53	45	40	33	57
SV030-1HZC	Cooling Full	80	69	64	56	54	47	47	40	61
	Heating Full	82	74	64	57	54	48	47	42	63
	FAN Only	72	69	64	55	50	44	37	29	59
SV042-1HZC	Cooling Full	83	72	64	59	55	50	45	41	63
	Heating Full	83	74	65	59	56	52	47	46	64
	FAN Only	83	72	64	58	55	49	43	37	63
SV060-1HZC	Cooling Full	79	67	62	58	57	48	42	37	61
	Heating Full	80	68	63	60	56	53	47	47	63
	FAN Only	73	66	61	56	54	47	41	36	59
SV070-1HZC	Cooling Full	83	72	67	65	60	53	43	41	66
	Heating Full	83	74	66	63	61	53	47	43	66
	FAN Only	76	71	66	64	60	51	42	43	65

\* Denotes background noise level is too high for the A-weighted value to be valid. Actual levels are less than or equal to stated values.

# Greensource i Series Model SV

## Water Source Heat Pump ½ to 6 Ton



# BOSCH

Ducted Discharge Sound Power - Octave Band Sound Power Levels dB, re 10-12 Watts										
Model	Load	Center Frequency - Hz								Overall (dBA)
		63	125	250	500	1000	2000	4000	8000	
SV007-1VTC	Cooling Full	82	65	57	58	60	52	53	54	64
	Heating Full	84	65	58	58	60	52	52	54	64*
	FAN Only	72	65	58	58	60	53	53	54	63
SV009-1VTC	Cooling Full	75	66	61	59	60	53	54	55	64
	Heating Full	79	66	61	59	59	53	54	55	64
	FAN Only	72	66	61	60	60	54	55	56	64
SV012-1VTC	Cooling Full	75	68	62	59	60	53	53	54	64
	Heating Full	80	70	66	62	61	54	53	55	66
	FAN Only	79	70	66	62	62	54	54	56	66
SV015-1VTC	Cooling Full	79	69	65	63	62	57	56	52	67
	Heating Full	80	70	65	63	63	57	57	53	68
	FAN Only	75	72	65	63	64	57	57	54	68
SV018-1VTC	Cooling Full	75	67	61	62	58	54	54	49	64
	Heating Full	78	71	61	62	58	53	53	50	64
	FAN Only	76	68	61	62	58	54	54	50	64
SV024-1VTC	Cooling Full	80	72	64	67	71	65	61	57	73
	Heating Full	80	73	65	68	72	65	62	58	74
	FAN Only	75	72	65	68	71	65	62	58	73
SV030-1VTC	Cooling Full	79	70	65	68	63	57	58	55	69
	Heating Full	76	73	66	67	63	57	58	56	69
	FAN Only	77	71	66	67	64	57	59	56	69
SV036-1VTC	Cooling Full	76	73	67	71	74	69	65	62	77
	Heating Full	79	79	68	71	75	70	66	63	78
	FAN Only	77	74	69	72	75	70	66	63	78
SV041-1VTC	Cooling Full	77	75	67	66	65	61	61	59	70
	Heating Full	79	80	67	66	66	62	62	60	71
	FAN Only	80	73	67	67	67	62	62	61	71
SV042-1VTC	Cooling Full	80	80	67	70	74	70	68	65	78
	Heating Full	82	82	67	70	73	70	68	65	77
	FAN Only	79	83	68	70	74	71	69	66	78

\* Denotes background noise level is too high for the A-weighted value to be valid. Actual levels are less than or equal to stated values.

**Greensource** i Series Model SV  
Water Source Heat Pump ½ to 6 Ton



Ducted Discharge Sound Power Continued - Octave Band Sound Power Levels dB, re 10-12 Watts										
Model	Load	Center Frequency - Hz								Overall (dBA)
		63	125	250	500	1000	2000	4000	8000	
SV048-1VTC	Cooling Full	83	75	69	72	75	71	69	66	79
	Heating Full	82	76	69	71	75	71	69	66	78
	FAN Only	82	75	69	72	76	72	70	67	79
SV060-1VTC	Cooling Full	80	75	65	68	71	67	65	61	75
	Heating Full	78	75	66	68	71	67	65	61	75
	FAN Only	77	77	67	69	73	68	65	62	76
SV070-1VTC	Cooling Full	85	79	74	73	73	70	67	63	78
	Heating Full	86	78	74	73	74	70	67	63	78
	FAN Only	86	80	75	74	74	70	68	64	79
SV012-1HZC	Cooling Full	82	66	62	56	60	55	54	55	65
	Heating Full	78	67	63	57	59	55	54	56	64
	FAN Only	83	67	63	57	60	55	54	56	65*
SV024-1HZC	Cooling Full	82	72	67	68	71	58	59	56	73
	Heating Full	78	73	68	69	69	60	61	58	72
	FAN Only	75	72	68	68	68	60	61	58	71
SV030-1HZC	Cooling Full	82	71	67	67	65	60	60	57	70
	Heating Full	79	72	68	68	68	60	61	58	71
	FAN Only	74	72	68	68	67	61	61	59	71
SV042-1HZC	Cooling Full	88	84	72	73	74	70	68	64	78
	Heating Full	90	84	74	74	73	70	68	64	78
	FAN Only	91	84	74	74	74	70	68	65	79
SV060-1HZC	Cooling Full	81	78	69	71	72	69	66	61	76
	Heating Full	81	79	70	71	73	69	66	62	76
	FAN Only	79	80	70	71	73	69	66	62	77
SV070-1HZC	Cooling Full	80	81	66	69	70	67	65	61	75
	Heating Full	79	76	68	69	70	67	65	61	75
	FAN Only	77	80	68	69	71	68	66	62	75

\* Denotes background noise level is too high for the A-weighted value to be valid. Actual levels are less than or equal to stated values.

# Greensource i Series Model SV

## Water Source Heat Pump ½ to 6 Ton



Field Installed Accessory - Pump/Valve Relay Kit																												
Part Number	SV007		SV009		SV012		SV015		SV018		SV024		SV030		SV036		SV041		SV042		SV048		SV060		SV070			
	VT	HZ	VT	HZ	VT	HZ	VT	HZ	VT	HZ	VT	HZ	VT	HZ	VT	HZ	VT	HZ	VT	HZ	VT	HZ	VT	HZ	VT	HZ	VT	HZ
7738003204	•	•	•	•	•	•	•	•	•	•	•	•	•	•	•	•	•	•	•	•	•	•	•	•	•	•	•	•

Field Installed Accessory - Swivel Connector Kit (two connectors per package)																													
Order Number	Type & Size	SV007		SV009		SV012		SV015		SV018		SV024		SV030		SV036		SV041		SV042		SV048		SV060		SV070			
		VT	HZ	VT	HZ	VT	HZ	VT	HZ	VT	HZ	VT	HZ	VT	HZ	VT	HZ	VT	HZ	VT	HZ	VT	HZ	VT	HZ	VT	HZ		
Where Used																													
7738003200	Male 3/4" NPT	•	•	•	•	•	•	•	•	•	•	•	•	•	•	•	•	•	•	•	•								
7738003201	Male 1" NPT																					•	•	•	•	•	•	•	•

Field Installed Accessory - SmartStart Assist Kit																												
Part Number	SV007		SV009		SV012		SV015		SV018		SV024		SV030		SV036		SV041		SV042		SV048		SV060		SV070			
	VT	HZ	VT	HZ	VT	HZ	VT	HZ	VT	HZ	VT	HZ	VT	HZ	VT	HZ	VT	HZ	VT	HZ	VT	HZ	VT	HZ	VT	HZ	VT	HZ
8733920430											•	•	•	•	•	•	•	•	•	•	•	•	•	•	•	•	•	•

Field Installed Accessory - Duct Mounted Electric Heaters 208/230V							
Nominal BTUH	Order #				Nominal CFM	Duct Flange Connection in Inches	Nominal Dimension in Inches
	5 kW	10 kW	15 kW	20 kW			
18000	7738002745	N/A	N/A	N/A	600	13.75 x 13.75	14 x 14
24000	7738002746	7738002747	N/A	N/A	800	13.75 x 13.75	14 x 14
30000	7738002748	7738002749	N/A	N/A	1000	15.75 x 15.75	16 x 16
36000	7738002748	7738002749	N/A	N/A	1200	15.75 x 15.75	16 x 16
42000	7738002747	7738002751	7738002752	N/A	1400	17.75 x 17.75	18 x 18
48000	7738002747	7738002751	7738002752	N/A	1600	17.75 x 17.75	18 x 18
60000	7738002747	7738002751	7738002752	7738002753	2000	17.75 x 17.75	18 x 18
70000	7738002747	7738002751	7738002752	7738002753	2200	17.75 x 17.75	18 x 18

**i** Duct mounted heaters are only available in single phase 208/230 V. Please refer to Manufacturer's Installation and Operation Manual for proper installation and guidelines. It is recommended to use a seven (7) conductor cables for thermostat interface. It is required for the duct mounted heater to have an independent power supply. In fiberglass duct systems, a metal sleeve MUST be used as an insert and support to the heater.



# Greensource i Series Model SV

## Water Source Heat Pump ½ to 6 Ton



# BOSCH

Field Installed Accessory - Stainless Steel Hose Kits						
Options	Option 1	Option 2	Option 3**	Option 4**,***	Option 5**, ***	Option 6**, ***
Hose Size (Length, Diameter)	Hoses Only with Swivel	Hose Kit Hoses with Ported Ball Valves, Swivel and One P/T*	Hose Kit with Automatic Flow Valve (AFV)*	Hose kit with AFV, Y-Strainer & Blow Down Valve*	Hose Kit with AFV and Electric Valve*	Hose Kit with AFV, Y-Strainer, BDV and Electric Valve*
	Part #	Part #	Part #	Part #	Part #	Part #
<b>12 Inch</b>						
1/2" L	T111H02121	T111H02122	T111H02123	T111H02124	T111H02125	T111H02126
<b>24 Inch</b>						
3/4" S	T111H03241	T111H03242	T111H03243	T111H03244	T111H03245	T111H03246
1" L	T111H04241	T111H04242	T111H04243	T111H04244	T111H04245	T111H04246
1" S	T111H04241	T111H04242	T111H04247	T111H04248	T111H04249	T111H04240
1 - 1/4" S	T111H05241	T111H05242	T111H05243	T111H05244	T111H05245	T111H05246
1 - 1/2" L	T111H06241	T111H06242	T111H06243	T111H06244	T111H06245	T111H06246
1 - 1/2" S	T111H06241	T111H06242	T111H06247	T111H06248	T111H06249	T111H06240
2" S	T111H08241	T111H08242	T111H08243	T111H08244	T111H08245	T111H08246
<b>36 Inch</b>						
3/4" S	T111H03361	T111H03362	T111H03363	T111H03364	T111H03365	T111H03366
1" L	T111H04361	T111H04362	T111H04363	T111H04364	T111H04365	T111H04366
1" S	T111H04361	T111H04362	T111H04367	T111H04368	T111H04369	T111H04360
1 - 1/4" S	T111H05361	T111H05362	T111H05363	T111H05364	T111H05365	T111H05366
1 - 1/2" L	T111H06361	T111H06362	T111H06363	T111H06364	T111H06365	T111H06366
1 - 1/2" S	T111H06361	T111H06362	T111H06367	T111H06368	T111H06369	T111H06360
2" S	T111H08361	T111H08362	T111H08363	T111H08364	T111H08365	T111H08366

\* All Hose Kits include S/R ported ball valves with swivel and P/T port.

\*\* 'L' and 'S' only apply to kit options 3 through 6

\*\*\* GMP's are required for hose kits in options 3-6

### Hose Kit Flow Rates by Size

Please see Technical Service Bulletin: Heat Pump Hose Kits – Water Flow Rates.

This document is located at [www.bosch-climate.us](http://www.bosch-climate.us) under Support Center > Downloads > Downloads for Bosch Products > Service Bulletins.

# Greensource i Series Model SV

## Water Source Heat Pump ½ to 6 Ton



### Field Installed Accessory - Bosch Connected Control Wi-Fi Thermostat

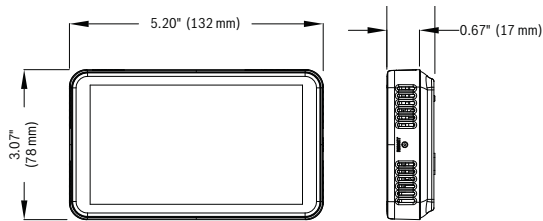
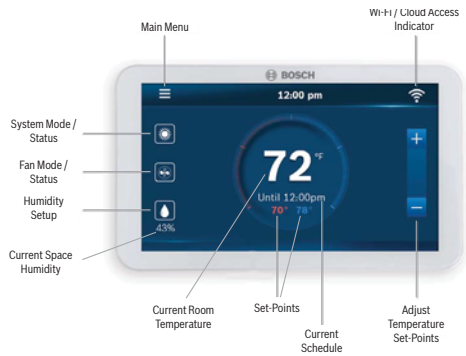

Description	Part Number	Heat	Cool	Humidity
Bosch Connected Control (BCC100)	8-733-948-009	4	2	Yes

#### Specifications

- 5 Inch Touch Screen 854 x 480 Pixels
- 7 Relay Outputs (Terminals) G, Y1, Y2, W1, W2, O/B, H/dH
- 1 Data Input (Pulse signals from Bosch WSHP)
- Displays Bosch Water Source Heat Pump Fault Messages
- Wi-Fi (802.11a/b/g/n) 2.4GHz (not compatible with 5GHz)
- FCC and IC Certification
- 5 Year Limited Warranty (see website for details: <https://www.bosch-climate.us/products-bosch-thermotechnology/thermostats-and-controls/residential-thermostats-controls/bcc100.html>)

#### Compatibility

- Conventional (Gas, Oil, Electric): Up to 2 Heat / 2 Cool
- Heat Pump (O/B to energize reversing valve in cool/heat): Up to 4 Heat / 2 Cool
- Supports up to 1 Accessory Unit: Humidifier or Dehumidifier (not provided by Bosch)
- Unit Modes: Heat, Cool, Auto, Off, Emergency Heat
- Fan Modes: Auto, On, Circulate
- Supports 2 Transformer Systems (Rh and Rc)
- C-Wire Required for Installation
- Supports Active and Passive Dehumidification without the need for external relays, such as Bosch Water Source Heat Pump products equipped with a Hot Gas Reheat Coil and/or ECM motor

# Greensource i Series Model SV

## Water Source Heat Pump ½ to 6 Ton



### Specification Guide

#### 1.0 General

Furnish and install BOSCH SV series water source heat pumps as indicated on the plans with capacities and characteristics as listed in the schedule and the specifications that follow. The units shall be manufactured in an ISO 9001:2000 certified facility.

#### 2.0 Horizontal/Vertical/CounterFlow Water Source Heat Pumps

Units shall be designed to operate throughout the range of entering fluid temperature of 50°F to 100°F in the cooling mode and 50°F to 80°F in the heating mode. Units shall have an operating range of entering fluid temperature between 40°F and 120°F in cooling and between 20°F to 90°F in the heating mode when equipped with the optional extended range package. Equivalent units from other manufacturers can be proposed provided approval to bid is given 10 days prior to bid closing. All equipment with a nominal capacity of 134,000 BTUH Total Cooling or lower must be listed in the current AHRI Applied Equipment Directory under the AHRI Standard ISO- 13256-1 Rating. All equipment in this section must meet or exceed the national standard minimum EER and COP as listed in ASHRAE 90.1 All units shall conform to UL1995 standard and certified to CAN/CSA C22.1 No 236 by Intertek-ETL. All units shall have ARI-13256-1 labels, and ETL/UL or NRTL or CSA labels.

#### 2.01 Basic Construction

- A.** Units shall have the air flow arrangement as shown on the plans. If units with these arrangements are not used, the contractor supplying the water source heat pumps is responsible for any extra costs incurred by other trades and must submit detailed mechanical drawings showing duct work requirements and changes or relocation of any other mechanical or electrical system. If other arrangements make servicing difficult the contractor must provide access panels and clear routes to ease service. The architect must approve all changes 10 days prior to bid.
- B.** All units shall have stainless steel drain pans to comply with this project's IAQ requirements. No exceptions shall be allowed.
- C.** All water source heat pumps shall be fabricated from sheet metal finished with galvanized steel. All interior surfaces shall be lined with 1/2 inch thick, multi density acoustic insulation. All insulation must meet NFPA 90A and be certified to meet the GREENGUARD Indoor Air Quality Standard for Low Emitting Products. One blower access panel and one compressor compartment access panels shall be removable with supply and return air duct work in place.
- D.** Unit shall have a floating base pan consisting of a ½" (12 mm)

thick high density rubber pad between the compressor base plate and the unit base pan to prevent transmission of vibration to the structure.

- E.** All units shall have a factory installed two sided filter rack capable of accepting one inch filters. Units shall have a 1 inch thick throwaway type glass fiber filter as standard. The filter rack shall incorporate a 1 inch duct flange. The contractor shall purchase one spare set of filters and replace factory-shipped filters upon completion of start-up.
  - Option to E: All units shall have a factory installed four sided filter rack with 2" MERV8 filters.
  - Option to E: All units shall have a factory installed four sided filter rack with 2" MERV13 filters.
- F.** Cabinets shall have separate holes and knockouts for entrance of line voltage and low voltage control wiring. Supply and return water connections shall be brass FPT fittings and shall be securely mounted flush to the cabinet allowing for connection to a flexible hose without the use of a back-up wrench. Water connections which protrude through the cabinet shall not be allowed.
- G.** Hanging brackets shall be provided as standard for horizontal units.
- H.** All units shall have condensate overflow switch , Air-coil and water-coil freeze sensor as standard.

#### 2.02 Fan and Motor Assembly

- A.** Units shall have a direct-drive centrifugal fan. The fan motor shall be a high efficiency PSC type. The fan motor shall be isolated from the fan housing by torsionally flexible isolation.
  - Option for A: The fan motor shall be a pre-programmed high efficiency constant torque ECM type (sizes 041, 060, and 070 only).
- B.** The fan and motor assembly must be capable of overcoming the external static pressures as shown on the schedule. External static pressure rating of the unit shall be based on a wet coil. Ratings based on a dry coil shall NOT be acceptable.
- C.** All units shall have removable blower inlet ring as standard for ease of service and maintenance.

### Specification Guide Continued

#### 2.03 Refrigerant Circuit

Units shall use R-410A refrigerant. All units shall have a factory sealed and fully charged refrigerant circuit with the following components:

- A.** Compressors shall be hermetic single stage rotary, or scroll type specifically designed for heat pump operation and shall be internally sprung, externally isolated (rotary), with thermal overload protection and mounted on rubber vibration isolators.
- B.** Refrigerant metering capillary tubes.
  - Option for B Units shall be equipped with the extended range package for low fluid temperature in the heating mode. The extended range package shall incorporate bi-directional refrigerant metering thermal expansion valves and an option insulated coaxial water coil for extended arrange application.
- C.** Finned tube refrigerant to air heat exchanger not exceeding 14 16 fins per inch. Refrigerant to air heat exchangers shall utilize enhanced aluminum fins and rifled copper tube construction rated to withstand 600 PSIG refrigerant working pressure. All air coils shall have non-ferrous aluminum end plates.
  - Option for C Coils shall have Duo-Guard tin electroplated copper tubing with polymer coated Aluminum Fins coating for enhanced protection against formicary and other types of corrosion. Copper tubes shall be tin coated and aluminum fins coated to pass 1000 hour ASTM B117 salt fog testing.
- D.** Reversing valve. Reversing valves shall be four way solenoid activated refrigerant valves which shall fail to the heating operation should the solenoid fail to function. Reversing valves which fail to the cooling operation shall not be allowed.
- E.** Coaxial (tube in tube) refrigerant to water heat exchanger. Refrigerant to water heat exchangers with copper inner water tube and steel outer refrigerant tube design rated to withstand 600 PSIG working refrigerant pressure and 400 PSIG working water pressure. Shell and Tube style refrigerant to water heat exchangers shall be treated as pressure vessels and shall require refrigerant pressure relief valves piped to the exterior of the building. The contractor supplying the water source heat pumps with Shell and Tube heat exchangers shall be responsible for any additional installation costs. Brazed Plate water to refrigerant heat exchangers shall require additional centrifugal separators added to the supply water piping at each unit. Each separator shall have an automated clean out valve piped to a waste line. The contractor supplying water source heat pumps with Brazed Plate heat exchangers shall be responsible for any additional costs.

- Option for E: Cupro-Nickel water coil – The refrigerant to water heat exchanger shall be of cupro-nickel inner water tube construction.

- F.** Safety controls including both a high pressure and low pressure switch. Temperature sensors shall not replace these safety switches. See the controls section of this specification for additional information.
- G.** Access fittings shall be factory installed on high and low pressure refrigerant lines to facilitate field service.
- H.** Activation of any safety device shall prevent compressor operation via a lockout circuit. The lockout circuit shall be reset at the thermostat or at the contractor supplied disconnect switch. Units which may be reset at the disconnect switch only shall not be acceptable. Refer to solid state safety circuit below.

#### 2.04 Electrical

A control box shall be located within the unit and shall contain a transformer, controls for the compressor, reversing valve and fan motor operation and shall have a terminal block for low voltage field wiring connections. The transformer shall be rated for a minimum 75 VA and shall have a push button reset circuit breaker on the secondary power.

All units shall be name-plated for use with time delay fuses or HACR circuit breakers. Unit controls shall be 24 volts.

#### 2.05 Solid State Safety Circuit

All units shall have a solid-state UPM safety control circuit with the following features:

1. Anti-short cycle time delay on compressor operation.
2. Random start on power up mode.
3. Brown out/Surge/Power Interruption protection.
4. Low Pressure Switch 120 second bypass timer.
5. Shutdown on the following fault indications:
  - a. high or low refrigerant pressure safety switches inputs.
  - b. Freeze sensors shall monitor refrigerant temperature to the water coil in the heating mode and refrigerant to air coil in the cooling mode.
6. Alarm output which closes for selectable dry contact closure or 24 VAC remote fault indication.
7. Alarm output selectable for constant output for general alarm notification, or pulse output for annunciation of the specific fault alarm.
8. Selectable reset of unit at thermostat or disconnect.

Specification Guide Continued

9. Automatic intelligent reset. Unit shall automatically reset after a safety shut down and restart the unit after the anti-short cycle timer and random start timer expire. Should the same fault re-occur within 60 minutes after reset, then a permanent lockout will occur. Reset attempts shall be selectable for either 2 or 4 tries. A condensate overflow will place the unit in an immediate hard lockout.
10. Ability to defeat time delays for servicing.
11. A light emitting diode (LED) to indicate safety alarms. The LED shall annunciate the following alarms:
  - a. high refrigerant pressure,
  - b. low refrigerant pressure,
  - c. low refrigerant temperature to the water coil in the heating operation,
  - d. Low refrigerant temperature to the air coil in the cooling mode,
  - e. high level of condensate in the drain pan,
  - f. brown out/surge/ power interruption.
12. The LED will display each fault condition as soon as the fault occurs. If a permanent lockout occurs, then the fault LED will display the type of fault until the unit is reset.
13. UL listed, CUL listed, and RFI, ESD, and transient protected.

**Freeze Protection:** A freeze stat shall sense the entering refrigerant temperature to the coaxial coil (in the heating mode) and shall activate the compressor lockout circuit when the refrigerant temperature drops below either 15°F or 26°F. The factory default is 26°F and the temperature setting may be set at 15°F by cutting the resistor (R42) located above dip switch. The freeze stat may not provide protection in the case of loss of flow in the heating mode. A flow switch or pressure differential switch is recommended to prevent unit operation in case of loss of flow. A second freeze sensor shall be mounted at the refrigerant inlet to the air coil. Should the refrigerant temperature drop below 26°F the unit will go into a soft lockout.

**Condensate overflow protection:** A condensate sensor shall activate the lockout circuit upon sensing a high level of condensate in the drain pan and immediately put the unit into a hard lockout. COP shall be standard on horizontal units

### 2.06 Options

- A. The following relays shall be factory installed in the unit
  - a) Auxiliary pump or valve relay to enable a pump or valve operation when calling for compressor operation.

### 3.0 Hose Kits

All units shall be connected with hoses. The hoses shall be either 2 or 3 feet long, braided stainless steel, fire rated hoses. Non fire rated hoses are not acceptable. Optional ball valves with P/T ports, flow controller, Y strainer and electric valve shall be included as specified in the schedule.